



Operator Manual

For printer model:

CG2 Series



CG208DT
CG212DT
Direct Thermal Type
203 dpi/ 305 dpi

CG208TT
CG212TT
Thermal Transfer Type
203 dpi/ 305 dpi

Read this Operator Manual before and during usage of the above product.
Keep this document handy for future reference.

NOTE: This equipment has been tested and found to comply with the limits for a Class B digital device, pursuant to part 15 of the FCC Rules. These limits are designed to provide reasonable protection against harmful interference in a residential installation. This equipment generates, uses and can radiate radio frequency energy and, if not installed and used in accordance with the instructions, may cause harmful interference to radio communications. However, there is no guarantee that interference will not occur in a particular installation. If this equipment does cause harmful interference to radio or television reception, which can be determined by turning the equipment off and on, the user is encouraged to try to correct the interference by one or more of the following measures:

- Reorient or relocate the receiving antenna.
- Increase the separation between the equipment and receiver.
- Connect the equipment into an outlet on a circuit different from that to which the receiver is connected.
- Consult the dealer or an experienced radio/ TV technician for help.

Be sure to ask your SATO representatives about our maintenance contracts to ensure peace of mind during your usage of SATO products.

Please refer to the back cover for SATO Group Member Company closest to your location. You may also visit our home page at www.satoworldwide.com for further updated details.

Copyrights

The contents of this document are proprietary information of SATO Corporation and/or its subsidiaries in Japan, the U.S and other countries. No part of this document may be reproduced, copied, translated or incorporated in any other material in any form or by any means, whether manual, graphic, electronic, mechanical or otherwise, without the prior written consent of SATO Corporation.

Limitation of Liability

SATO Corporation and/or its subsidiaries in Japan, the U.S and other countries make no representations or warranties of any kind regarding this material, including, but not limited to, implied warranties of merchantability and fitness for a particular purpose. SATO Corporation shall not be held responsible for errors contained herein or any omissions from this material or for any damages, whether direct, indirect, incidental or consequential, in connection with the furnishing, distribution, performance or use of this material.

SATO Corporation reserves the right to make changes and/or improvements in this product and document without notice at any time.

Trademarks

SATO is a registered trademark of SATO Corporation and/or its subsidiaries in Japan, the U.S and other countries.

Version: SI-CG2-01rA-01-04-09OM

© Copyright 2009 SATO Corporation.



All rights reserved.

Safety Precautions

Please read the following information carefully before installing and using the printer.

Pictographic Symbols

This instruction manual and the printer labels use a variety of pictographic symbols to facilitate safe and correct use of the printer and to prevent injury to others and property damage. The symbols and meanings for them are given below. Be sure to understand these symbols well before reading the main text.

 Warning	Ignoring the instructions marked by this symbol and erroneously operating the printer could result in death or serious injury.
 Caution	Ignoring the instructions marked by this symbol and erroneously operating the printer could result in injury or property damage.

Example Pictographs





The  pictograph means "Caution is required." A specific warning symbol is contained inside this pictograph (The symbol at left is for electric shock).

















The  pictograph means "Should not be done." What is specifically prohibited is contained in or near the pictograph (The symbol at left means "Disassembly prohibited").



The  pictograph means "Must be done." What is specifically to be done is contained in the pictograph (The symbol at left means "Unplug the power cord from the outlet").

 Warning		
<p>Do not set on an unstable area</p> <ul style="list-style-type: none"> Do not set on an unstable area, such as a wobbly table or slanted area or an area subject to strong vibration. If the printer falls off or topples over, it could injure someone. <p>Do not place containers full of water or other liquid on the printer</p> <ul style="list-style-type: none"> Do not place flower vases, cups, or other containers holding liquids, such as water or chemicals, or small metal objects near the printer. If they are spilled and get inside the printer, immediately turn off the power switch, unplug the power cord from the outlet, and contact the dealer, or Support Center. Using the printer in this condition could cause a fire or electric shock. <p>Do not put objects inside the printer</p> <ul style="list-style-type: none"> Do not insert or drop in metal or burnable objects inside the printer's openings (cable outlets, etc.). If foreign objects do get inside the printer, immediately turn off the power switch, unplug the power cord from the outlet, and contact the dealer, or Support Center. Using the printer in this condition could cause a fire or electric shock. <p>Do not use other than the specified voltage</p> <ul style="list-style-type: none"> Do not use other than the specified voltage. Doing so could result in fire or electric shock. 	<p>Always ground the connections</p> <ul style="list-style-type: none"> Always connect the printer's ground wire to a ground. Not grounding the ground wire could result in electric shock. <p>Handling of the power cord</p> <ul style="list-style-type: none"> Do not damage, break, or modify the power cord. Also, do not place heavy objects on the power cord, heat it, or pull it because doing so could damage the power cord and cause a fire or electric shock. If the power cord becomes damaged (core is exposed, wires broken, etc.), contact the dealer, or Support Center. Using the power cord in this condition could cause a fire or electric shock. Do not modify, excessively bend, twist, or pull the power cord. Using the power cord in such a condition could cause a fire or electric shock. <p>When the printer has been dropped or broken</p> <ul style="list-style-type: none"> If the printer is dropped or broken, immediately turn off the power switch, unplug the power cord from the outlet, and contact the dealer, or Support Center. Using the printer in this condition could cause a fire or electric shock. 	<p>Do not use the printer when something is abnormal about it</p> <ul style="list-style-type: none"> Continuing to use the printer in the event something is abnormal about it, such as smoke or unusual smells coming from it, could result in fire or electric shock. Immediately turn off the power switch, unplug the power cord from the outlet, and contact the dealer, or Support Center for repairs. It is dangerous for the customer to try to repair it, so absolutely do not attempt repairs on your own. <p>Do not disassemble the printer</p> <ul style="list-style-type: none"> Do not disassemble or modify the printer. Doing so could result in fire or electric shock. Ask the store, dealer, or Support Center to conduct internal inspections, adjustments, and repairs. <p>Regarding the cutter</p> <ul style="list-style-type: none"> Do not touch the cutter with your hands or do not put something into the cutter. Doing so could result in an injury. <p>Using the head cleaning fluid</p> <ul style="list-style-type: none"> Use of flame or heat around the head cleaning fluid is prohibited. Absolutely do not heat it or subject it to flames. Keep the fluid out of reach of children to prevent them from accidentally drinking it. If the fluid is drunk, immediately consult with a physician.

 Caution		
<p>Do not place in areas with high humidity</p> <p> • Do not place the printer in areas with high humidity or where condensation forms. If condensation forms, immediately turn off the power switch and do not use the printer until it dries. Using the printer while condensation is on it could result in electric shock.</p> <p>Carrying the Printer</p> <p> • When moving the printer, always unplug the power cord from the outlet and check to make sure all external wires are disconnected before moving it.</p> <p> Moving the printer with the wires still connected could damage the cords or connecting wires and result in a fire or electrical shock.</p> <p> • Do not carry the printer with paper loaded in it. The paper could fall out and cause an injury.</p> <p>• When setting the printer on the floor or a stand, make sure not to get your fingers or hands pinched under the printer feet.</p> <p>Power supply</p> <p> • Do not operate the power switch or plug in/unplug the power cord with wet hands. Doing so could result in electric shock.</p>	<p>Power cord</p> <p> • Keep the power cord away from hot devices. Getting the power cord close to hot devices could cause the cord's covering to melt and cause a fire or electrical shock.</p> <p> • When unplugging the power cord from the outlet, be sure to hold it by the plug. Pulling it by the cord could expose or break the core wires and cause a fire or electric shock.</p> <p>• The power cord set that comes with the printer is especially made for this printer. Do not use it with any other electrical devices.</p> <p>Top cover</p> <p> • Be careful not to get your fingers pinched when opening or closing the top cover. Also be careful the top cover does not slip off and drop.</p> <p>Print head</p> <p> • The print head is hot after printing. Be careful not to get burned when replacing paper or cleaning immediately after printing.</p> <p> • Touching the edge of the print head with bare hands could result in injury. Be careful not to become injured when replacing paper or cleaning.</p>	<p>Loading paper</p> <p> • When loading roll paper, be careful not to get your fingers pinched between the paper roll and the supply unit.</p> <p>When not using the printer for a long time</p> <p> • When not using the printer for a long time, unplug the power cord from the outlet to maintain safety.</p> <p>During maintenance and cleaning</p> <p> • When maintaining and cleaning the printer, unplug the power cord from the outlet to maintain safety.</p>

Precautions for Installation and Handling

Printer operation can be affected by the printer environment.

Refer to the following instructions for installation and handling of CG2 Series printer.

Select a Safe Location

Place the printer on a surface that is flat and level.



If the surface is not flat and level, this may result in poor print quality. This may also cause malfunction and shorten the life span of the printer.

Do not place the printer on a location that produces vibration.

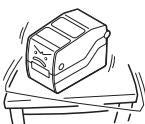

Do not carry the printer when the roll label is set. Giving serious vibration or shock to the printer may cause malfunction and shorten the life span of the printer.

Do not place the printer near crane or pressing machine.

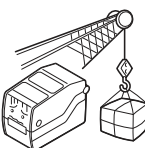

Machinery, such as cranes and pressing machines require large amount of power. Being near this machinery may cause electrical noise or voltage reduction. Avoid such locations to reduce the risk of malfunction or damage to the printer.

Keep the printer out of high temperature and humidity.



Avoid locations subject to extreme or rapid changes in temperature or humidity. Exposure to these conditions may cause electrical problems within the printer.

Do not place the printer in a location subject to water or oil.



Do not place the printer in a location where it will be splashed with water or oil. Water or oil entering inside the printer may cause a fire, electric shock, or malfunction.

Avoid dust.



Dust build up may result in poor print quality. This may cause not only malfunction but also shorten the life span of the printer.

Keep out of direct sunlight.

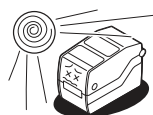

This printer has a built-in optical sensor. Exposure to direct sunlight will make the sensor less responsive and may cause the label to be sensed incorrectly. Close the top cover when printing.

Power Supply

This printer requires an AC power supply.

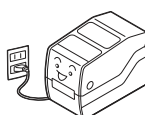

Be sure to connect the printer to an AC power supply via the supplied AC adapter. Failure to do so may result in malfunction.

Connect the power cord to a grounded power outlet.

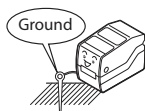

Make sure that the printer is plugged into a grounded power outlet.

Provide a stable source of electricity to the printer.

Do not share the power outlets with other appliances such as a heater and refrigerator requiring a measurable amount of power. Also, avoid using the power outlet near where such appliances are plugged into. This may cause voltage reduction and malfunction.

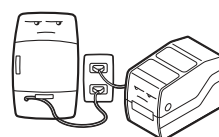

TABLE OF CONTENTS

Introduction.....	1 - 1
1.1 Features of the Printer	1 - 1
1.2 Unpacking	1 - 2
1.3 Parts Identification	1 - 3
Installation.....	2 - 1
2.1 Site Location	2 - 2
2.2 Media Selection	2 - 2
2.3 Loading Labels or Tags	2 - 3
2.4 Loading the Carbon Ribbon (For CG208TT, CG212TT only)	2 - 7
2.5 Connections	2 - 10
Operation and Configuration.....	3 - 1
3.1 Operator Panel.....	3 - 2
3.2 Operating Modes	3 - 3
3.3 User Test Print Mode	3 - 5
3.4 Factory Test Print Mode.....	3 - 9
3.5 Operation Setting Mode	3 - 11
3.6 Program Download Mode	3 - 13
3.7 Font Download Mode.....	3 - 15
3.8 Default Setting Mode	3 - 16
3.9 HEX Dump Mode	3 - 17
3.10 Print Mode of Wireless LAN Setting.....	3 - 17
3.11 Error Occurrence While Downloading.....	3 - 20
3.12 Print Head Check.....	3 - 20
3.13 Printer Configurations Setting	3 - 23
3.14 Head Over-Temperature Protection.....	3 - 25
3.15 Protection Function when Using AC Adapter.....	3 - 26
3.16 Measures for RFID error	3 - 27
Troubleshooting	4 - 1
4.1 Error signal troubleshooting	4 - 2
4.2 Troubleshooting table	4 - 4
4.3 Interface troubleshooting	4 - 6
4.4 Test print troubleshooting	4 - 7
Cleaning and Maintenance	5 - 1
5.1 Cleaning The Print Head, Platen and Rollers	5 - 2
5.2 How To Clean The Printer (Cleaning Kit).....	5 - 2
5.3 How To Clean The Printer (Cleaning Sheet)	5 - 3
5.4 Easy Replacement of Parts	5 - 4
5.5 Adjusting Print Quality.....	5 - 6
General Specifications.....	6 - 1
6.1 Printer Basic Specifications	6 - 1
6.2 Optional Accessories Specifications	6 - 7

Interface Specifications	7 - 1
7.1 Interface types	7 - 1
7.2 RS232C Serial Interface	7 - 2
7.3 Universal Serial Bus (USB) Interface	7 - 6
7.4 Local Area Network (LAN) Ethernet and Wireless LAN	7 - 8
Appendix	8 - 1
8.1 Optional Accessories - Cutter	8 - 2
8.2 Optional Accessories - Dispenser	8 - 4
8.3 Positions of sensors and options	8 - 6
8.4 15mm (0.6") Wide Wristband	8 - 7
8.5 Operation Mode Selection	8 - 8
8.6 Base Reference Point	8 - 9
8.7 Offset position Adjustment	8 - 12
8.8 Paper End	8 - 13
8.9 Ribbon End	8 - 14
Sato Group of Companies	9 - 1
Sato Group of Companies	9 - 2

This page is intentionally left blank

1

INTRODUCTION

Thank you for your investment in this SATO printer product.

This Operators Manual contains the basic information about the installation, setup, configuration, operation and maintenance of the printer.

A total of eight topics are covered herein, and they are organized as follows:

- Section 1: Introduction
- Section 2: Installation
- Section 3: Operation and Configuration
- Section 4: Troubleshooting
- Section 5: Cleaning and Maintenance
- Section 6: General Specifications
- Section 7: Interface Specifications
- Section 8: Appendix

It is recommended that you read carefully and become familiar with each section before installing and maintaining the printer. Refer to the **Table Of Contents** at the front of this manual to search for the relevant information needed. All page numbers in this manual consist of a section number followed by the page number within the stated section.

This section assists you in unpacking the printer from the shipping container. You will also be guided through a familiarization tour of the main parts and controls.

The following information is provided herein:

- Features of the printer
- Unpacking
- Parts Identification

1.1 FEATURES OF THE PRINTER

The CG2 series is 2 inch Compact Desktop printer (Thermal Transfer or Direct Thermal). With a 32-bit RISC CPU, 4 ips print speed, and 4MB Flash Memory, the CG2 series is an economical printer with numerous features making it suitable for a wide range of applications. The key features of the CG2 series are:

- High Print Resolution with crisp printing quality (203dpi or 305dpi)
- Flexible Interface
- Cutter and Dispenser Printer Options
- HF RFID Option
- Easy Media Loading
- Standalone Capability using Keypad
- Tool-less changing of print head and platen roller for easier maintenance
- Codepage Support and Emulations
- Anti-Microbial casing is ideally for clinical environments or food processing industry
- Safety Top Cover Latch
- Distinctive Chassis color

1.2 UNPACKING

When unpacking the printer, take note of the following:

1. The box should stay right-side up.
Lift the printer out of the box carefully.
2. Remove all the packaging from the printer.
3. Remove the accessory items from their protective containers.
4. Set the printer on a solid, flat surface. Inspect the shipping container and printer for any sign of damage that may have occurred during shipping. Please note that SATO shall hold no liability of any damage of any kind sustained during shipping of the product.

Notes

- If the printer has been stored in the cold, allow it to reach room temperature before turning it on.
- Please do not discard the original packaging box and cushioning material after installing the printer. They may be needed in future, if the printer needs to be shipped for repairs.

1.2.1 Included Accessories

After unpacking the printer, verify that you have the following materials:

User Documents
(Quick Guide, Warranty, etc)

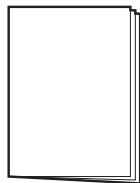

Power plug*

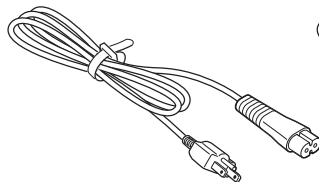

AC adapter

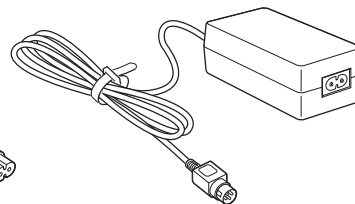

The shape of the power plug may vary, depending on the location where it was purchased.

1.3 PARTS IDENTIFICATION

Front view

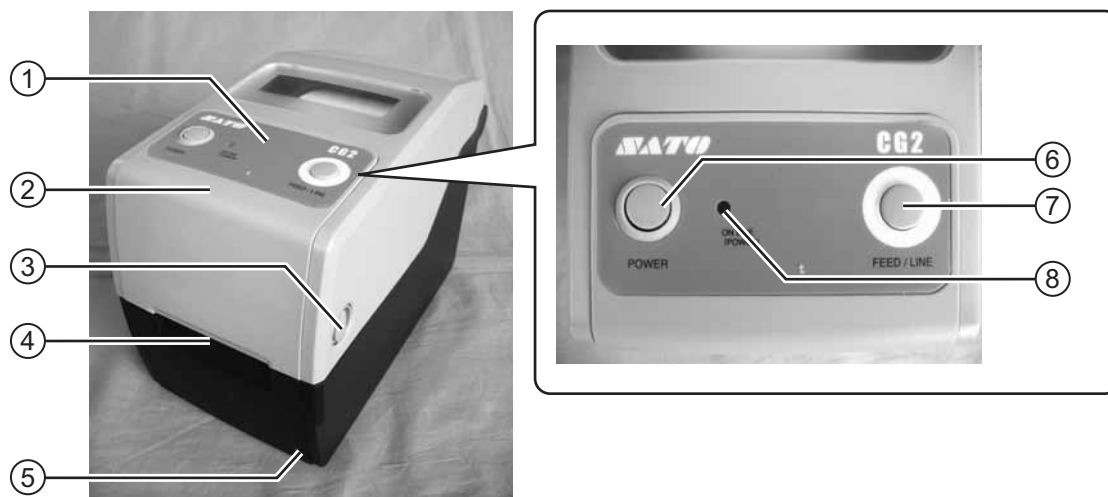

- | | |
|-------------------------------------------------------------------------------------------------------------------------------------------------------------------------------------------------------------------------------------------------------------------------------------------------------------------------------------------------------------------------------------------------------------------------------------------------------------------------------------------------------------------------------------------------------------------------------------------------------------------------------------------------------------------------------------------|-------------------------------------------------------------------------------------------------------------------------------------------------------------------------------------------------------------------------------------------------------------------------------------------------------------------------------------------------------------|
| <p>① Operator panel
It consists of two contact buttons and one two-color (red and green) LED indicator.</p> <p>② Top cover
Open this cover to load the media and ribbon.</p> <p>③ Cover open/close latch
Pull these latches on both sides of the printer forward to open the Top cover of the printer.</p> <p>④ Media ejection slot
Opening for media output.</p> <p>⑤ VR3 potentiometer (Offset/ Pitch)
This potentiometer adjusts the option (Cutter, Dispenser, Tear-off) stop position (offset position).

Pitch position adjustment is also available in the Pitch adjustment VR mode of Factory Adjustment mode.</p> | <p>⑥ POWER button
Press this button to turn the power on or off.</p> <p>⑦ FEED/LINE button
Press this button to select the printer status (online/ offline) or to feed the paper.</p> <p>⑧ ON LINE (POWER) LED indicator
The LED lights green when the printer is online and blinks green when the printer is offline.</p> |
|-------------------------------------------------------------------------------------------------------------------------------------------------------------------------------------------------------------------------------------------------------------------------------------------------------------------------------------------------------------------------------------------------------------------------------------------------------------------------------------------------------------------------------------------------------------------------------------------------------------------------------------------------------------------------------------------|-------------------------------------------------------------------------------------------------------------------------------------------------------------------------------------------------------------------------------------------------------------------------------------------------------------------------------------------------------------|

1.3 PARTS IDENTIFICATION (cont'd)

Back view

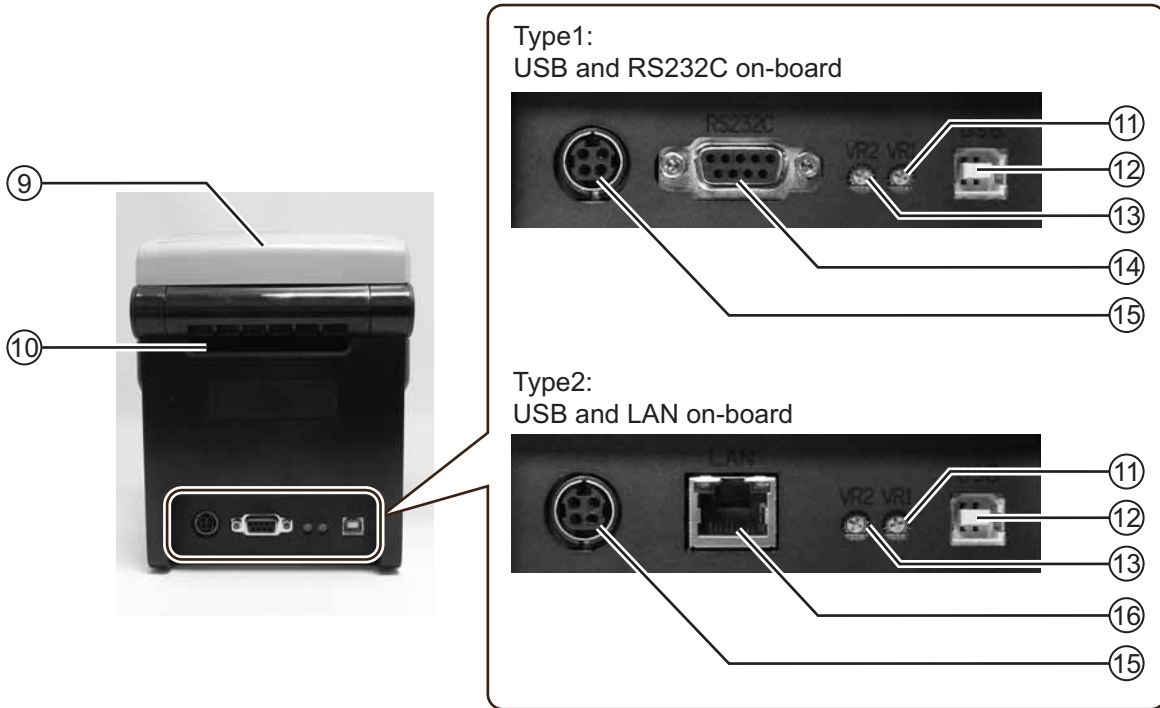

⑨ **Top cover**

⑩ **Media inlet**

An opening for Fan-folded media or media from unwinder to feed in to the printer.

⑪ **VR1 potentiometer (Gap)**

This potentiometer is used to adjust the sensing level for the gap sensor.

⑫ **USB interface terminal**

To connect printer to the host computer using the USB interface.

Or, to connect the optional wireless LAN interface unit to the printer (Only applicable for Type 1 board).

⑬ **VR2 potentiometer (I-mark)**

This potentiometer is used to adjust the sensing level of the I-mark sensor.

⑭ **RS-232C interface terminal**

To connect printer to the host computer using RS-232C interface.

Or, to connect the optional Keypad to the printer.

⑮ **DC input power terminal**

Supplies power to the printer by inserting the power cable via the AC adapter.

⑯ **LAN interface terminal**

To connect printer to the host computer using LAN interface.

1.2 PARTS IDENTIFICATION (cont'd)

Internal view when Top cover is opened

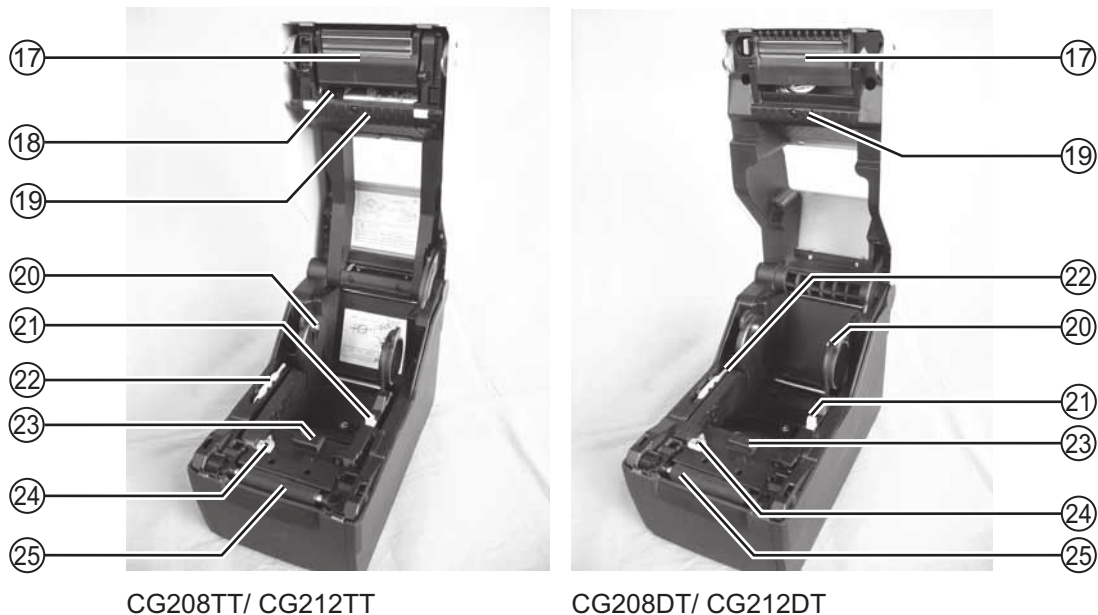

CG208TT/ CG212TT

CG208DT/ CG212DT

-
- ①7 Print head**
 This component is used to print on the paper. Perform maintenance at regular intervals.
 - ①8 Ribbon unit**
 Used to load the ribbon and wind up the used ribbon.
 - ①9 Upper Gap sensor**
 Detects the gap of the label or center-hole in the tag stock.
 - ②0 Roll media holder**
 To hold the roll media.
 - ②1 Media guide slide lever**
 Set to meet the size of the media used.
 - ②2 Supplied yellow microdriver**
 Used to adjust the potentiometers.
 - ②3 Lower Gap sensor**
 Detects the gap of the label or center-hole in the tag stock.
 - ②4 I-mark (Paper) sensor**
 Detects the I-mark on the media.
 - ②5 Platen roller**
 This roller feeds the paper. Perform maintenance at regular intervals.

This page is intentionally left blank

2

INSTALLATION

This section assists you in installing consumable media in the printer, as well as adjustment instructions and installing other optional attachment units.

The following information is provided:

- 2.1 Site Location
- 2.2 Media Selection
- 2.3 Loading Labels or Tags
- 2.4 Loading the Carbon Ribbon (For CG208TT, CG212TT only)
- 2.5 Connections

2.1 SITE LOCATION

Consider the following when setting up the printer:

- Place the printer on a solid flat surface with adequate space. Make sure there is enough space above the printer to provide clearance for the top cover to swing open.
- Place it away from hazardous materials or dusty environments.
- Place it within operational distance of the host computer, within interface cable specifications.

2.2 MEDIA SELECTION

The size and type of the labels or tags to be printed should have been taken into consideration before printer purchase. Ideally, the media width will be equal to, or just narrower than, the print head. Using media that does not cover the print head will allow the platen roller to tread on it and wear it out. The media edge will also wear a groove in the platen roller, which can affect print quality.

Note:

For optimal print performance and durability, **please use SATO-certified label and ribbon supplies on this printer.** Using supplies not tested and approved for use by SATO can result in unnecessary wear and damage to vital parts of the printer, and may void the warranty.

This printer can print on roll media or fan-folded media. The methods used for loading roll media and fan-folded media differ. The printer uses sensors to detect I-marks, gap or center hole on the media in order to precisely position the print content.

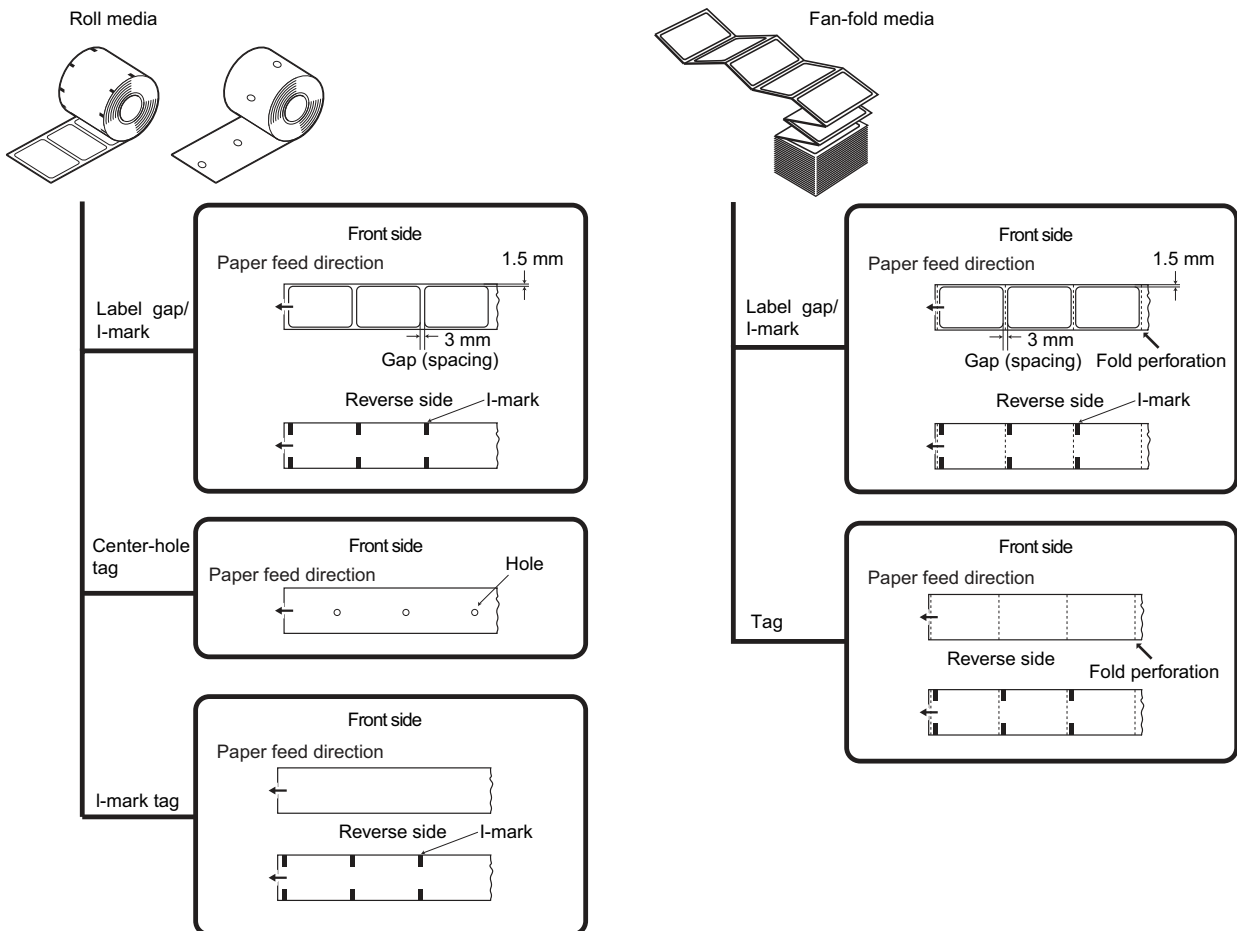

2.3 LOADING LABELS OR TAGS

2.3.1 Loading Roll media

1. With the power supply off, pull the **cover open/close latches** ① on both sides of the printer toward you to unlock the top cover, and then open the **top cover** ②. Make sure that the cover rests firmly so that it will not fall forward and injure your hands.



2. While holding the **media guide slide lever**, adjust the width of the **media holder** ① to match the media size.

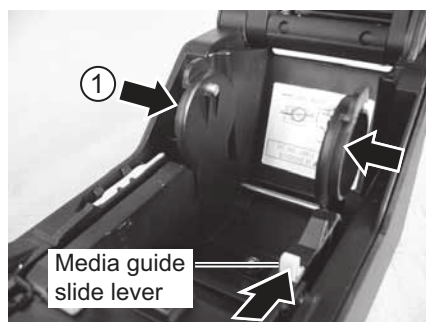

3. Load the media onto the **media holder**.



4. After pulling out the media, pass the media through the **media guides** and place the leading edge of the media on top of the **platen roller**. Make sure the printed side of the media is facing upwards.

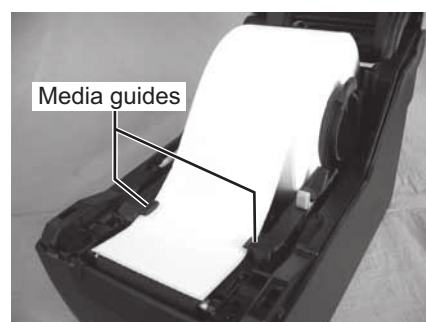

Printed side should face upwards

2.3 LOADING LABELS OR TAGS (cont'd)

5. Close the **top cover** until it clicks into position.

Notes:

- Be careful not to get your fingers pinched while closing the top cover.
- If the optional dispenser has been purchased, see **Section 8.2 Optional Accessories - Dispenser** on how to route the media.



6. After loading of the media, turns on the power. The printer is online and the **ON LINE (POWER)** indicator lights green. When the printer is ready, press the **FEED/LINE** button to output the leading part of the media.

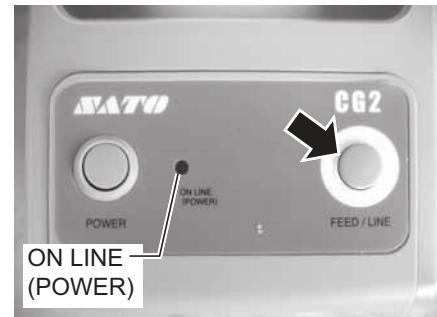

 **Caution**

- When replacing media, bear in mind that the print head and its surrounding area remain hot. Keep your fingers away from these areas to prevent injury.
- Avoid touching even the edge of the print head with your bare hands.

2.3 LOADING LABELS OR TAGS (cont'd)

2.3.2 Loading Fan-folded media

1. With the power supply off, pull the **cover open/close latches** on both sides of the printer toward you to unlock the top cover, and then open the top cover. Make sure that the cover rests firmly so that it will not fall forward and injure your hands.



2. Pass the fan-folded media through the opened window at the rear of the unit. Make sure the printed side of the media is facing upwards.



3. While holding the **media guide slide lever**, adjust the width of the **media holder** ① to match the media size. After pulling out the media, pass the media through the **media guides** and place the leading edge of the media on top of the **platen roller**.

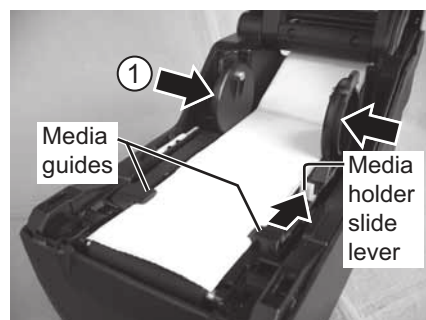

4. Close the **top cover** until it clicks into position.

Notes:

- Be careful not to get your fingers pinched while closing the top cover.
- If the optional cutter or dispenser has been purchased, see **Section 8.1 Optional Accessories - Cutter** and **Section 8.2 Optional Accessories - Dispenser** on how to route the media.

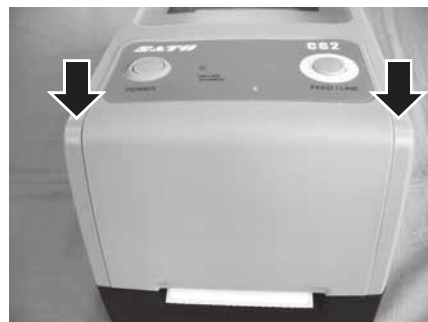

2.3 LOADING LABELS OR TAGS (cont'd)

5. After loading of the media, turn on the power.
The printer is online and the **ON LINE (POWER)** LED lights green.
When the printer is ready, press the **FEED/LINE** button to output the leading part of the media.

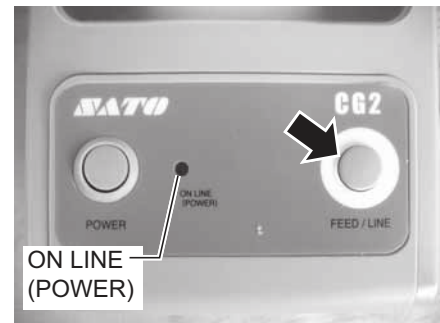

Caution

- When replacing media, bear in mind that the print head and its surrounding area remain hot. Keep your fingers away from these areas to prevent injury.
- Avoid touching even the edge of the print head with your bare hands.

2.3.3 Overview of the Roll media and Fan-folded media loading path

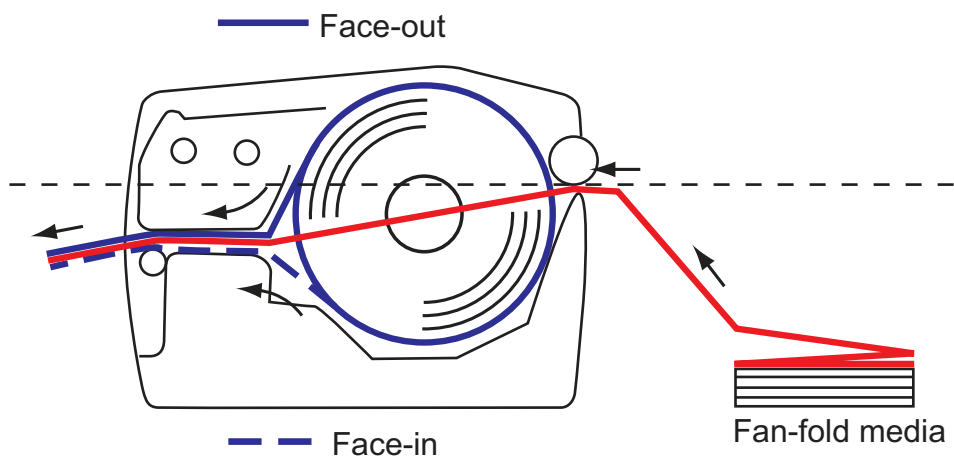

2.4 LOADING THE CARBON RIBBON (FOR CG208TT, CG212TT ONLY)

The CG208TT and CG212TT printers enable two types of printing, **Thermal transfer** and **Direct thermal**. **Thermal transfer** paper media requires the use of carbon ribbon for print application. In such a scenario, it is the carbon ribbon that contains the ink that will be transferred to the media. **Direct thermal** paper media has a coating on the surface that is made visible through the application of heat from the print head. In this case, there is no need of loading the carbon ribbon.

1. With the power supply off, pull the **cover open/close latches** on both sides of the printer toward you to unlock the top cover, and then open the top cover. Make sure that the cover rests firmly so that it will not fall forward and injure your hands.



2. Pull the **lever** on the middle of the **ribbon unit** downward to pull out the **ribbon unit**. Then simply let down the **ribbon unit**. There is a stopper midway through its movement range that will prevent the ribbon unit from snapping down.

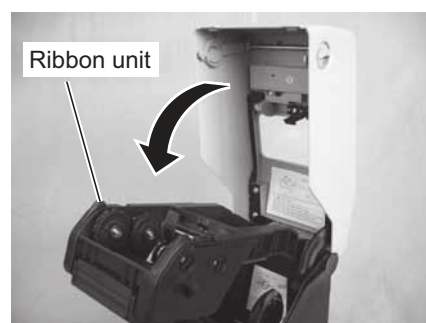
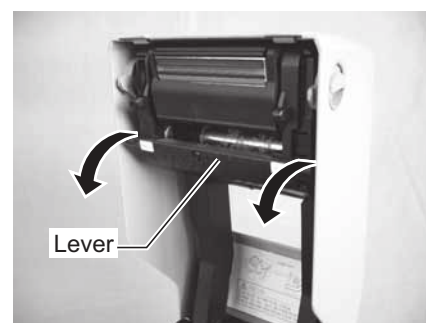

2.4 LOADING THE CARBON RIBBON (FOR CG208TT, CG212TT ONLY) (cont'd)

3. Open the carbon ribbon package, and then load the ribbon in the **ribbon supply unit**.
With the ribbon winding in clockwise direction, fix and push in the ribbon roll to the right side of the **ribbon supply unit** ①. Then fix the other side of the ribbon roll to the left of the **ribbon supply unit** ②. Turn the ribbon roll till the core snap on the protrusion of the left ribbon supply unit.

Note:

Use only genuine SATO carbon ribbons for maximum print quality and printer durability.

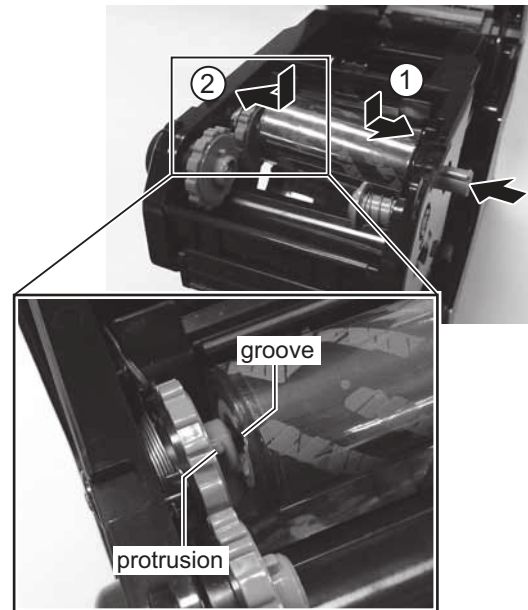

4. Mount the empty ribbon core on the **ribbon wind-up unit** with the same manner as in step 3 above.
When loading the carbon ribbon for the first time, an empty ribbon core is supplied with the printer. However, the subsequent ribbon core can be obtained from the last used up ribbon roll.

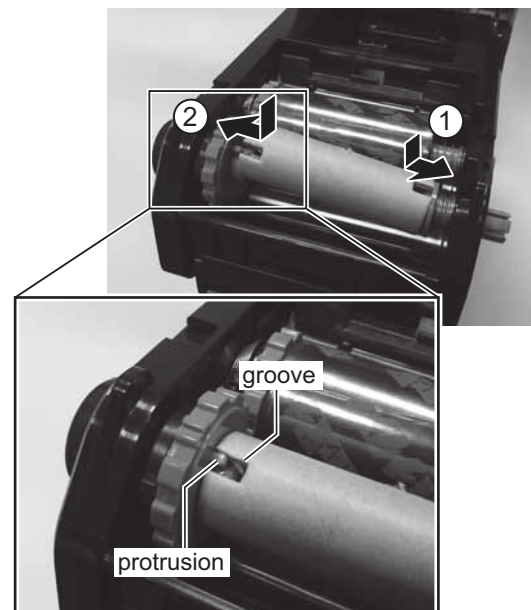

2.4 LOADING THE CARBON RIBBON (FOR CG208TT, CG212TT ONLY) (cont'd)

5. From the **ribbon supply unit**, pass the carbon ribbon underneath the print head assembly to the **ribbon wind-up unit**.

Affix the carbon ribbon to the ribbon core using adhesive tape, etc., and wind it up several times in the direction shown by the turn arrow.

Confirm that the ribbon has been loaded as shown in the figure below or as illustrated on the inner side of the top cover.

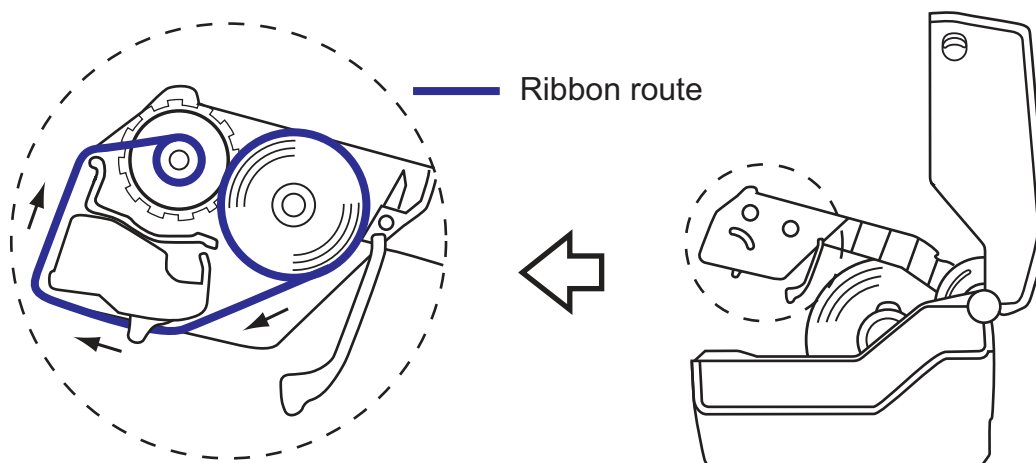
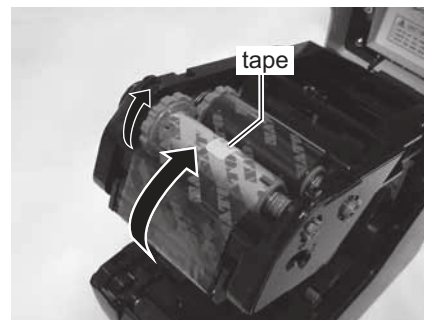

Note:

The dull side (ink side) of the ribbon should be facing outward as it travels through the print head assembly.

6. Close the **top cover** until it clicks into position.

Note:

- Be careful not to get your fingers pinched while closing the top cover.

7. After loading the media and the carbon ribbon, do a test print to check that the media roll and ribbon have been loaded properly. See **Section 3.3 User Test Print Mode** for instructions on how to run test print.

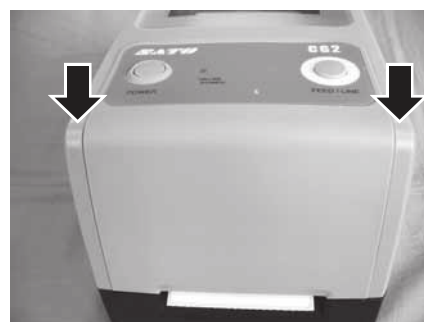

Caution

- When replacing carbon ribbon, bear in mind that the print head and its surrounding area remain hot. Keep your fingers away from these areas to prevent injury.
- Avoid touching even the edge of the print head with your bare hands.

2.5 CONNECTIONS (cont'd)

2.5.2 Connecting the optional keypad

The optional keypad can be connected to the RS-232C terminal of the Type 1, CG2 series printer, thus providing a stand-alone feature. This feature enable users to enter simple command to the printer, by the connected keypad, without connecting to a host computer.

1. Make sure that power cable is not connected to the printer.
2. Connect the cable from the optional keypad to the **RS232C** terminal at the back of the printer. Make sure the connector is correctly oriented. Secure the printer with one hand, and insert the connector firmly.
3. Set the printer for use with the keypad. Refer to **Section 3.5 Operation Setting Mode** and perform the procedures to set the printer to **Keypad mode**.
In step 4 of this procedure, briefly press of the **FEED/LINE** button repeatedly until the **ON LINE (POWER)** indicator has changed to display red in long intervals.

●→●→○→○→●→●→○→○
flashes red in a long interval

Note:

If Keypad is selected, even if the keypad device is not connected, other interfaces cannot be activated.

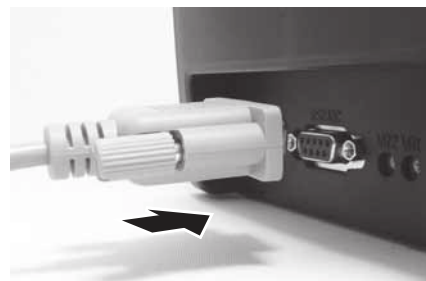

2.5.3 Connecting the Power Cable

Warning

- Be sure to connect the ground wire. Failure to do so may cause an electric shock.
- Do not operate the power switch or insert/remove the power cable while your hands are wet. Doing so may cause an electric shock.

Caution

The power cable and the AC adapter provided with this printer are for use with this printer only. They cannot be used with other electrical devices.

1. Connect the AC power cable to the AC adapter.

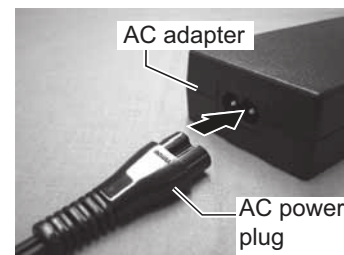

2.5 CONNECTIONS (cont'd)

2. Connect the DC power plug from the AC adapter to the **DC input power terminal** on the back of the printer. Make sure the flat side of the DC power plug is facing upward. Secure the printer with one hand, and insert the cable firmly.

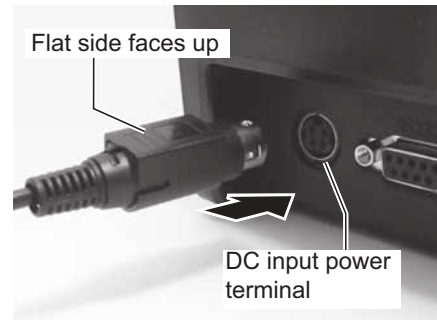

3. Insert the AC power plug into a AC power outlet. Make sure that the AC voltage of your region is within the range of AC 100 to 240V, 50/60 Hz. A 3-pin plug is attached to the power cord provided with your printer. One of these pins is the ground wire. You must use a 3-pin power outlet. The plug will not work with a 2-pin power outlet.

* The shape of the power plug may vary depending on the location where the printer was purchased.

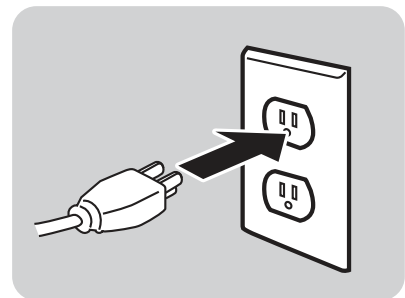

2.5.4 Turning On the Power



Warning

Do not operate the power switch or insert/remove the power cable while your hands are wet. Doing so may cause an electric shock.

Press the **POWER** on the operation panel of the unit. The **ON LINE (POWER)** indicator displays red, then green.

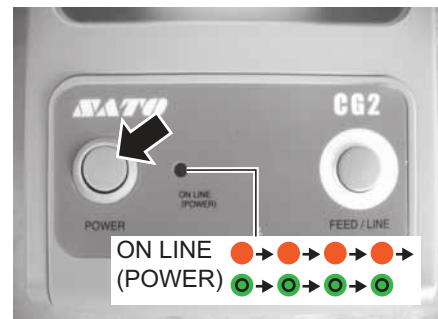

2.5.5 Turning Off the Power

When you have completed the printing job, turn the printer off.

Press and hold the **POWER** button until the **ON LINE (POWER)** indicator displays red and then turns off.

Be sure to confirm that the printer is in the offline status before turning it off.

If there is any printed paper remaining in the printer, cut it off.



3

OPERATION AND CONFIGURATION

Before using the printer, it is best to read this manual thoroughly. Otherwise, you may disturb default settings on which the instructional procedures in this manual are based.

Most of the printer's settings are controlled via standard SBPL commands or by using the provided SATO Utilities Tool application.

Some printer settings may be manually configured via the **POWER** and **FEED/LINE** buttons with the **ON LINE(POWER)** indicator on the front of printer and/or via the potentiometers located on the printer's front and back. All of the printer's buttons, and potentiometers are used either singularly, or together, to perform configuration activities. The instructions to these operations are described in this section.

3.1 OPERATOR PANEL

The operator panel located on the top front, consists of two buttons and one two-color (red and green) LED indicator.

- **POWER** button
Press **POWER** button to turn on or off the printer.
Press **POWER** button together with **FEED/LINE** button to enter various operating modes.
- **FEED/LINE** button
 - Press **FEED/LINE** button during normal print operation to pause the printing and set the printer to offline mode. Press again to toggle the printer between the online and offline mode.
 - When printer idles in online mode, press the **FEED/LINE** button to feed a blank label.
 - Press the **FEED/LINE** button during to pause label feed and go offline.
 - The printer will go offline after opening and closing the top cover. Press the **FEED/LINE** button to make the printer goes online.

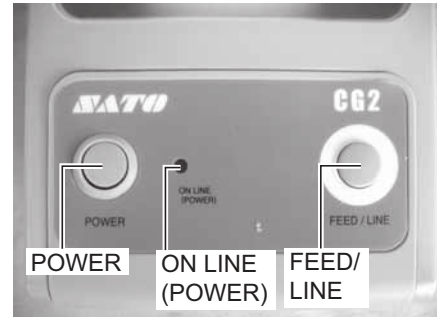

- **ON LINE(POWER)** indicator

When the printer is in normal mode, this two-color indicator notifies the user of various status conditions:
Green - Illuminates when printer is ready to receive data or is in printing mode (Online).

Blinks when the printer is in offline mode.

Red - Illuminates or blinks when there is a system fault, for example, paper end.

Off - When the printer is turned off.

During different operation modes, the **ON LINE(POWER)** indicator lights and flashes differently. In this section, the combination of the following symbols has been used, for describing the indicator lighting sequence. Refer to the example listed below for lighting sequences.

Indicator symbol	Status
○	Off
●	Solid red light
●	Solid green light

The repeating patterns are as shown in the below examples. The sequences are indicated as from left to right. One LED indication light is approximate 200ms, and two indication lights in a row are for about 400ms.

Example 1	Indicator: Solid red light.	●→●→●→●
Example 2	Indicator: Solid green light.	●→●→●→●
Example 3	Indicator: Blinking red light.	●→○→●→○
Example 4	Indicator: Blinking green light.	●→○→●→○
Example 5	Indicator: Solid red & green light in turn	●→●→●→●
Example 6	Indicator: off	○→○→○→○

3.1 OPERATOR PANEL (cont'd)

CG2 series printer has 3 potentiometers for adjustment of the printer setting. **VR1** and **VR2** potentiometers are located at the bottom back panel of the printer, while **VR3** potentiometer is located at the bottom right of the front panel.

- **VR1** (Gap) potentiometer
This potentiometer is used to adjust the sensing level for the gap sensor. This adjustment should be done in the Factory Adjustment Mode. Please refer to SATO authorised servicing personnel for details.
- **VR2** (I-mark) potentiometer
This potentiometer is used to adjust the sensing level of the I-mark sensor. This adjustment should be done in the Factory Adjustment Mode. Please refer to SATO authorised servicing personnel for details.
- **VR3** (Offset/ Pitch position) potentiometer
This potentiometer adjusts the option (Cutter, Dispenser, Tear-off) stop position (offset position).
Offset adjustment with VR3:
 $\pm 3.75\text{mm}$, $\pm 0.15''$ (that is $\pm 45\text{dot}$ for 305dpi printer)
Offset adjustment with command: $\pm 99\text{dot}$
Total adjustment can be done for this printer: $\pm 144\text{dot}$ (for 305dpi printer)
Pitch position adjustment is available only in the Factory Adjustment mode. Please refer to SATO authorised servicing personnel for details.
The setting value can be clear with factory clear (All clear).

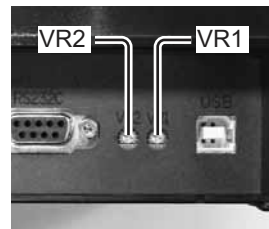

3.2 OPERATING MODES

The operating status of this printer can be set within one of the following modes:

1. Normal mode (including Online/Offline modes)
2. User Test print mode
3. Factory Test print mode
4. Operation Setting mode:
 - Program download mode
 - Font download mode
 - Default setting mode
 - HEX Dump mode
 - USB/ Wireless LAN interface
 - RS-232C/ LAN interface
 - Keypad selection
5. Print mode of Wireless LAN setting (Applicable only when the optional Wireless LAN is installed.)

The various modes are accessed by pressing the **POWER** button, **FEED/LINE** button or with certain printer settings in force; and releasing these buttons at certain pattern of **ON LINE(POWER)** indicator's lighting sequence.

3.2 OPERATING MODES (cont'd)

The following flow chart provides a clear summary of all the modes and their access method.

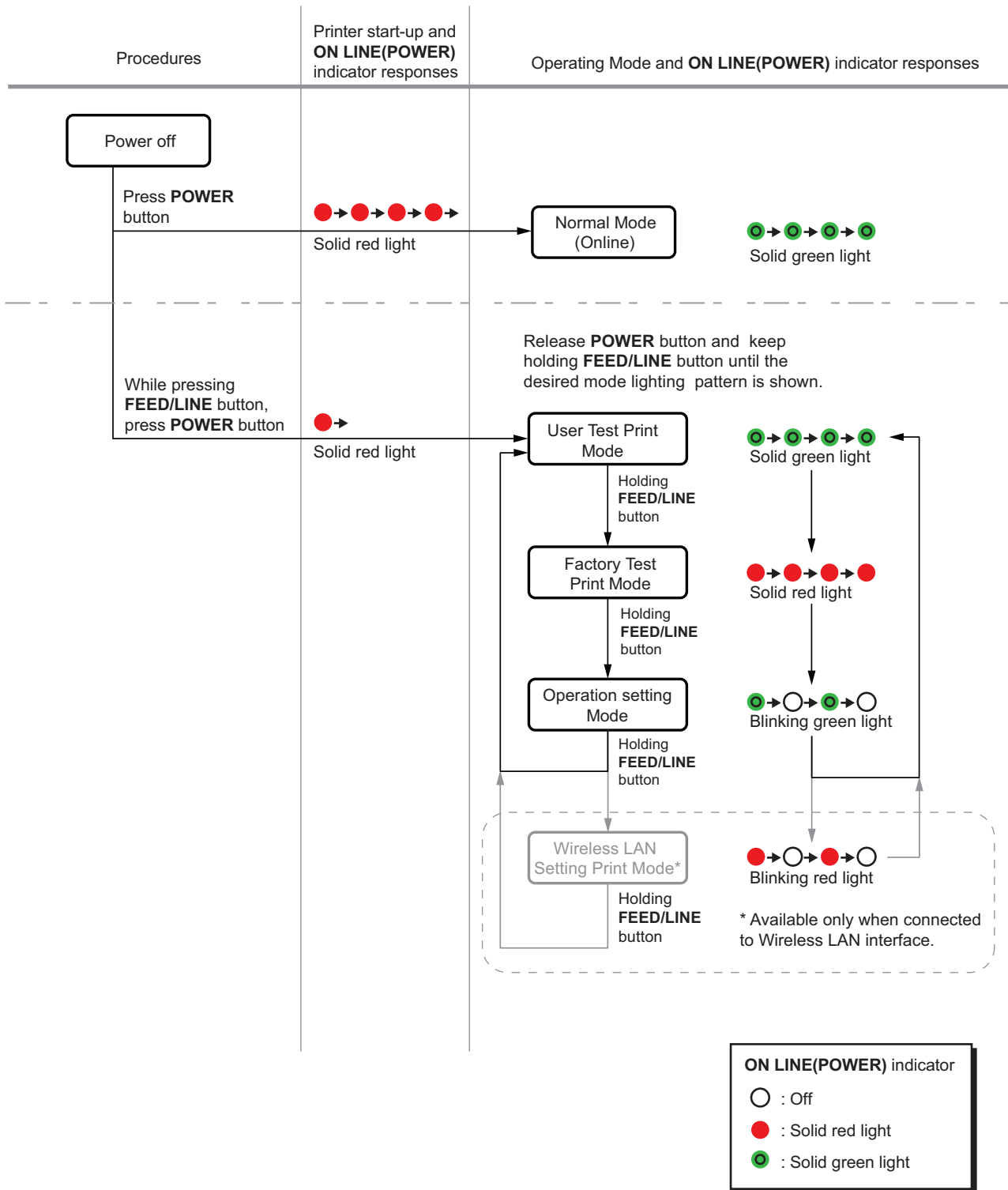







3.3 USER TEST PRINT MODE

This mode produces test labels for diagnostic purposes.

Preparation:

Make sure the media or ribbon (if require) are properly loaded into the printer.

Procedures	Printer status	ON LINE (POWER) indication
1 While pressing FEED/LINE button, press POWER button	Printer start-up	 → Solid red light
2 Release POWER button and keep holding FEED/LINE button.	User Test Print Mode. (The printer will cyclically advance to next mode as long the FEED/LINE button is kept holding.)	 → Solid green light
3 Release FEED/LINE button when ON LINE (POWER) indicator changes to solid green light.	User Test Print mode activated and enters to test print pause mode.	 → Solid green light  → Blinking green light
4 Press FEED/LINE button to start test printing.	User Test Print start and print continuously.	 → Solid green light
Press FEED/LINE button to pause the test printing. Press again to resume.	User Test Print paused.	 → Blinking green light

Notes:

- If you missed out the chance of releasing the **FEED/LINE** button in step 3 above, just keep holding the **FEED/LINE** button and wait for the next cycle.
- If you released the **FEED/LINE** button at the wrong **ONLINE(POWER)** indication, just turn off the power and restart the procedure again.
- The printer will continuously print the user test labels until the **FEED/LINE** button is pressed. The printing is paused and will resume printing if the **FEED/LINE** button is press again.

To terminate the User Test Print mode

First, make sure to press the **FEED/LINE** button to pause the test printing, then press **POWER** to turn off the printer.

3.3 USER TEST PRINT MODE (cont'd)

3.3.1 Output Data of the User Test Print

The output data of the User Test Print shows the current settings of the printer.

These output data are printed out in 3 pieces, with the printing area of 60mm[2.36"] (Width) x 80mm[3.15"] (Pitch), Standard.

First print-out (Settings)

No.	Print Item		Contents of the print data
1	Model	Printer model name	CG208TT(*), CG212TT(*) CG208DT, CG212DT *: "T" is printed for thermal transfer print. "D" is printed for direct thermal print.
2	Offset	Offset value (Vertical and horizontal directions)	(H)±396 (V)±396
3	Pitch Offset	Pitch offset value	±099
4	Cut Offset	Cut position offset value	±099
5	Peel Offset	Peel off position offset value	±099
6	Tear Off Offset	Tear off position offset value	±099
7	Label Size	Label size (Pitch/Width)	(P)**** x (W)***
8	Print Speed	Print speed	50mm/s 75mm/s 100mm/s
9	Print Darkness	Print darkness	1A~5A 1B~5B 1C~5C
10	Sensor Type	Sensor type	I-mark Gap Gap (Wrist Band) None
11	Paper End Search	Paper end detection method	ROLL / TAG
12	Zero Slash	Zero slash	ON/ OFF
13	Proportional Pitch	Proportional pitch	ON/ OFF
14	Initial Feed	Initial feed	ON/ OFF
15	Option waiting time	Option waiting time	****ms
16	Proto-codes	Protocol code setting value (Standard / Nonstandard)	Standard / Nonstandard
17	Operation mode	Operation mode	CONTINUOUS TEAR OFF CUT DISPENSER
18	Head Check	Head Check	ON/ OFF

3.3 USER TEST PRINT MODE (cont'd)

Second print-out (Protocol code setting values)

No.	Print Item	
1	STX	
2	ETX	
3	ESC	
4	ENQ	
5	CAN	
6	NULL	
7	OFFLINE	
8	AUTO ONLINE	
9	ZERO SLASH	Zero slash
10	EURO	Euro code

Third print-out (Interface)

Type 1: USB and RS-232C on board

No.	Print Item		Contents of the print data
1	Selected Interface	In-use interface	USB / RS-232C / Keypad
2	Interface 1	Interface 1(USB)	USB
3	Buffer Type	Buffer type	Multi
4	Protocol	Protocol	Driver
5	Interface 2	Interface 2(RS-232C)	RS-232C
6	Buffer Type	Buffer type	1 item / Multi
7	Protocol	Protocol	ER/RS XON/XOF Driver Status3

Type 2: USB and LAN on board

No.	Print Item		Contents of the print data
1	Selected Interface	In-use interface	USB / LAN
2	Interface 1	Interface 1(USB)	USB
3	Buffer Type	Buffer type	Multi
4	Protocol	Protocol	Driver
5	Interface 2	Interface 2(LAN)	LAN
6	LAN Ver/Date	LAN module F/W version, creation date	**.** / YY.MM.DD
7	Buffer Type	Buffer type	Multi
8	Protocol	Protocol	Driver(CYC) Driver(ENQ) Status3
9	MAC Address	MAC address	*****

Section 3: Operation and Configuration

No.	Print Item		Contents of the print data
10	IP Address	IP address	000.000.000.000 ~ 255.255.255.255
11	Subnet Mask	Subnet mask	000.000.000.000 ~ 255.255.255.255
12	Default Gateway	Default gateway	000.000.000.000 ~ 255.255.255.255
13	DHCP	DHCP	Enable / Disable
14	RARP	RARP	Enable / Disable

Optional Wireless LAN installed on Type 1 board (with RS-232C)

No.	Print Item		Contents of the print data
1	Selected Interface	In-use interface	WIRELESS LAN
2	Interface 1	Interface 1(W-LAN)	WLAN
3	LAN Ver/Date	LAN module F/W version, creation date	**.** / YY.MM.DD
4	Buffer Type	Buffer type	Multi
5	Protocol	Protocol	Driver(CYC) Driver(ENQ) Status3
6	MAC Address	MAC address	***.**.*.**.*.**
7	IP Address	IP address	000.000.000.000 ~ 255.255.255.255
8	Subnet Mask	Subnet mask	000.000.000.000 ~ 255.255.255.255
9	Default Gateway	Default gateway	000.000.000.000 ~ 255.255.255.255
10	DHCP	DHCP	ON OFF(Auto-IP) OFF
11	RARP	RARP	ON OFF
12	W-LAN Mode	Wireless LAN mode	Ad hoc Infrastructure(SSID)
13	SSID	SSID	1~32-chr string
14	Channel	Channel	1~11
15	Security Mode	Security type	OFF WEP WPA WPA2 DynamicWEP
16	Interface 2	Interface 2(RS-232C)	RS-232C
17	Buffer Type	Buffer type	1 item / Multi
18	Protocol	Protocol	ER/RS XON/XOF Driver Status3

3.4 FACTORY TEST PRINT MODE

This mode produces test labels for diagnostic purposes.

Preparation:

Make sure the media or ribbon (if require) are properly loaded into the printer.

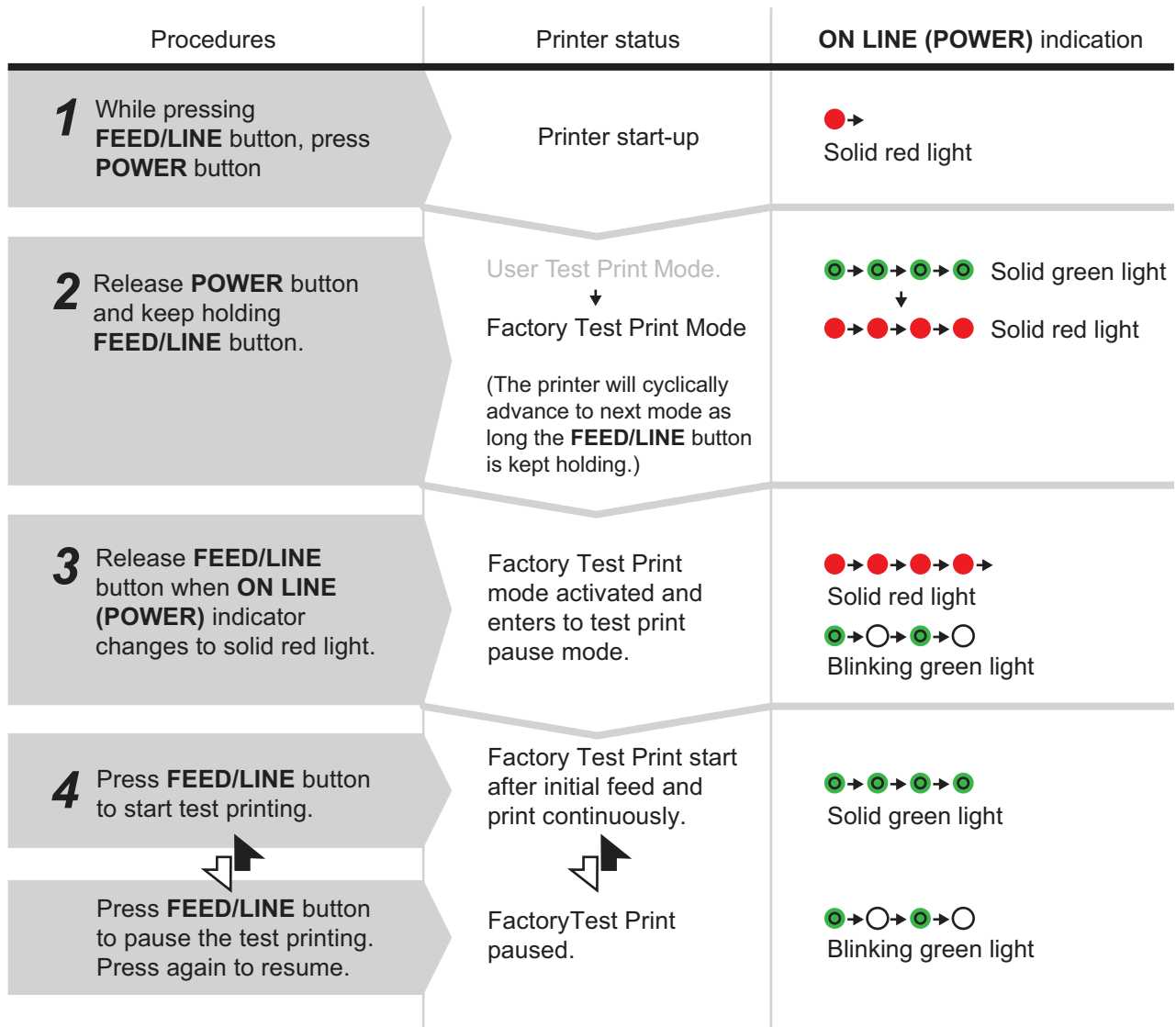

Notes:

- If you missed out the chance of releasing the **FEED/LINE** button in step 3 above, just keep holding the **FEED/LINE** button and wait for the next cycle.
- If you released the **FEED/LINE** button at the wrong **ONLINE(POWER)** indication, just turn off the power and restart the procedure again.
- The printer will continuously print the Factory test labels until the **FEED/LINE** button is pressed. The printing is paused and will resume printing if the **FEED/LINE** button is press again.

To terminate the Factory Test Print mode

First, make sure to press the **FEED/LINE** button to pause the test printing, then press **POWER** to turn off the printer.

3.4 FACTORY TEST PRINT MODE (cont'd)

3.4.1 Output Data of the Factory Test Print

The output data of the Factory Test Print shows the internal operating parameters of the printer. These output data are printed out in 3 pieces, with the media size of 60mm[2.36"] (Width) x 80mm[3.15"] (Pitch), Standard.

First print-out (Settings)

No.	Print Item		Contents of the print data
1	Model	Printer model name	CG208TT(*), CG212TT(*) CG208DT, CG212DT *: "T" is printed for thermal transfer print. "D" is printed for direct thermal print.
2	Firm Ver	Printer F/W version	32.**.**
3	Firm Date	Printer F/W creation date	YY.MM.DD
4	Font Version	Font version	**.** (R)
5	CONT/USB Serial	USB serial No.	*****
6	Life Counter	Life counter	*.* Km
7	Head Counter1	Head counter 1	*.* Km
8	Head Counter2	Head counter 2	*.* Km
9	Head Counter3	Head counter 3	*.* Km
10	Cutter Counter	Cutter counter	*****
11	Head Check	Head check result	OK / NG
12	Thermistor	Print head temperature	***
13	Sensor Type	Sensor type	I-mark Gap Gap (Wrist Band) None
14	Sensor Level Low	Average minimum value of pitch sensor	*.* V
15	Sensor Level High	Average maximum value of pitch sensor	*.* V
16	Sensor Slice Level	Pitch sensor slice level	*.* V
17	Pitch Offset[VR3]	Print start position	±30 DOT [203dpi] ±45 DOT [305dpi]
18	Option Offset[VR3]	Option stop position	±30 DOT [203dpi] ±45 DOT [305dpi]
19	FROM1 CHECK SUM	Printer F/W: Font: Check sum	(B)**** (P)**** (F)**** (A)****
20	LAN(WLAN) CHECK SUM	LAN(WLAN) F/W check sum	(B)**** (P)**** (A)****

3.4 FACTORY TEST PRINT MODE (cont'd)

Second print-out (Settings)

This setting information is similar to the first print-out in user test print mode. Refer to **Section 3.3.1 Output Data of the User Test Print** for details.

Third print-out (Interface)

This interface information is similar to the third print-out in user test print mode. Refer to **Section 3.3.1 Output Data of the User Test Print** for details.

3.5 OPERATION SETTING MODE

The operation setting mode enable further selection of the functions of the printer. These are:

- Program download mode
- Font download mode
- Default setting mode
- HEX dump mode
- USB/ Wireless LAN interface
- RS-232C/ LAN interface
- Keypad selection

Selection of the above operation setting modes are as shown below.

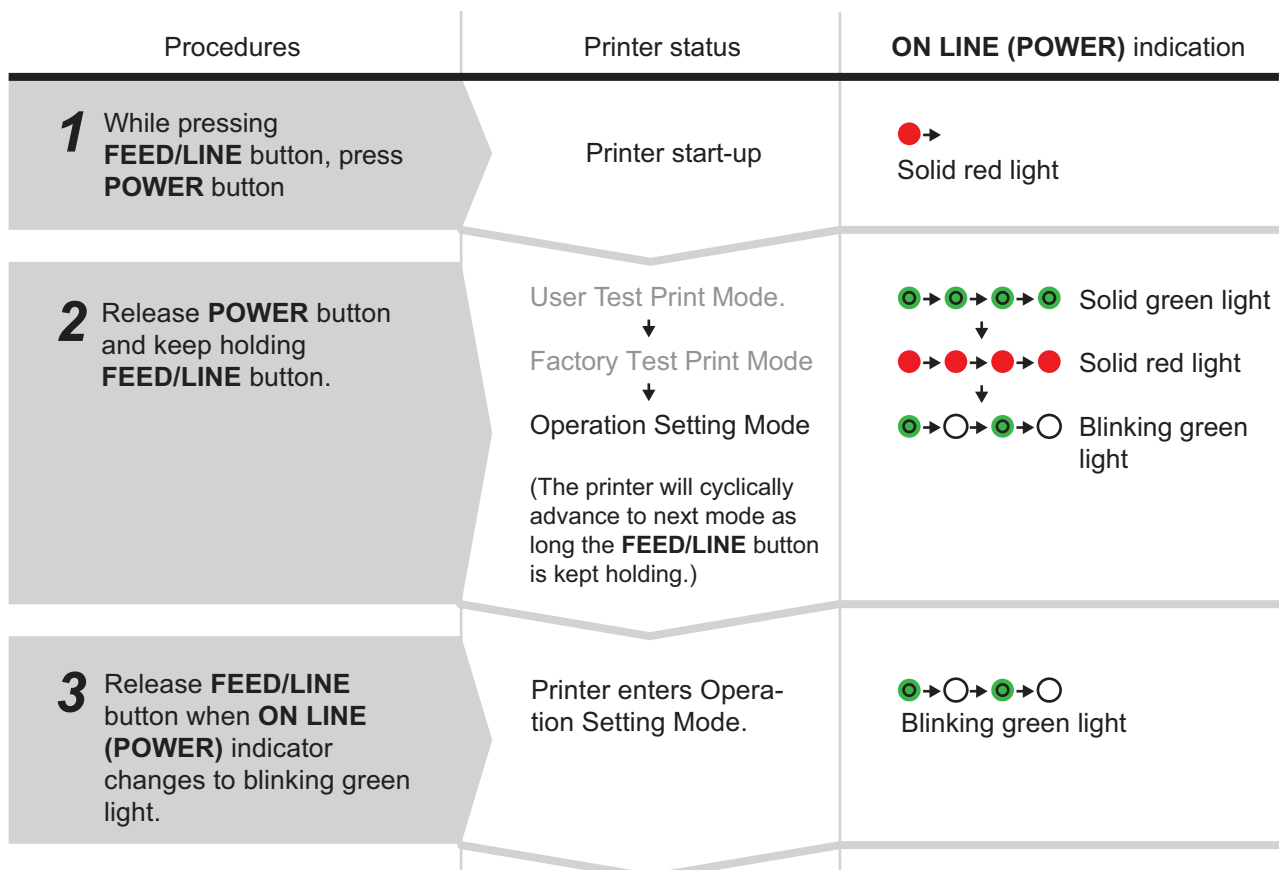

To be continued on the next page. 

3.5 OPERATION SETTING MODE (cont'd)

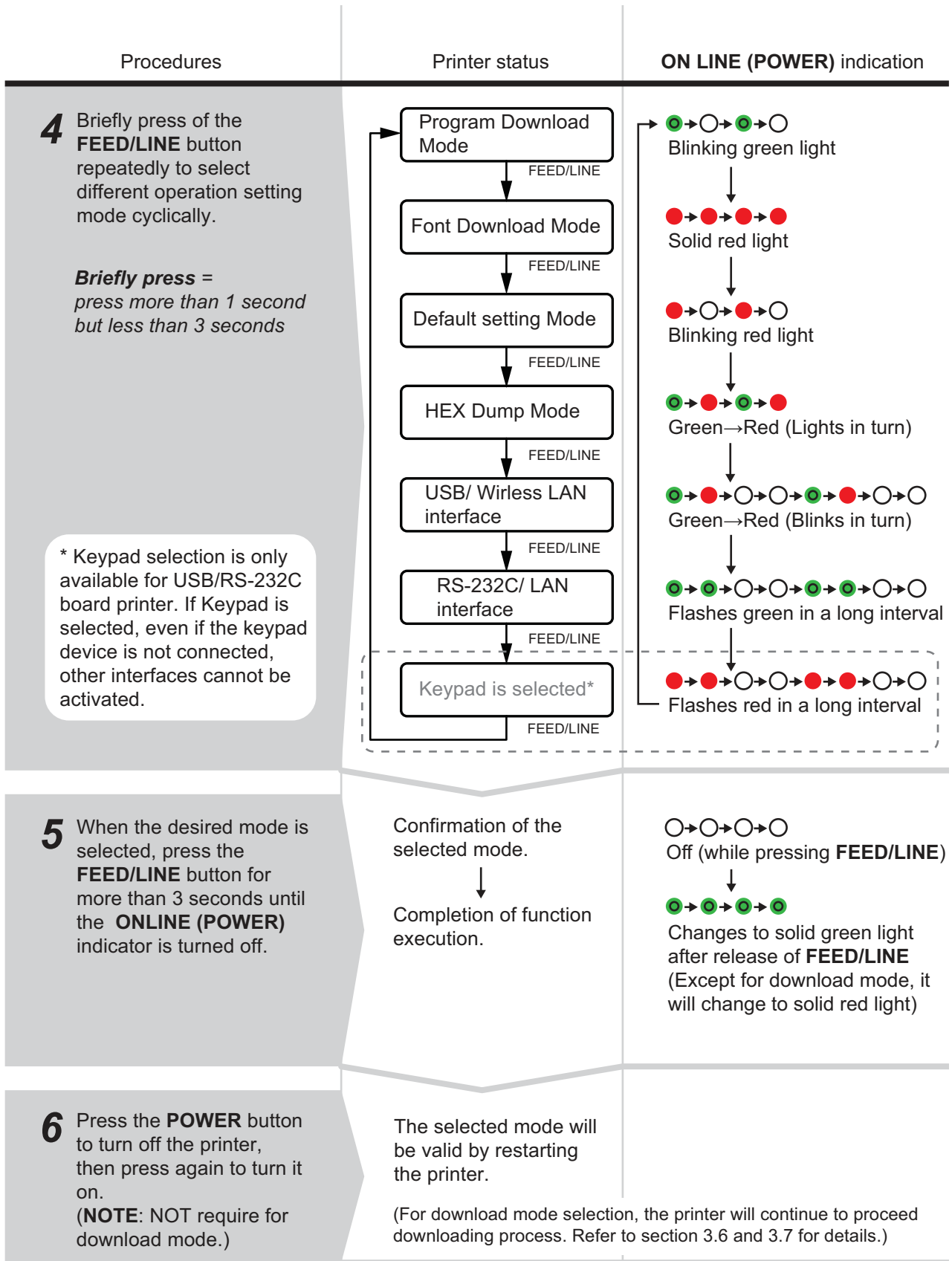

3.5 OPERATION SETTING MODE (cont'd)

Notes:

- Briefly press **FEED/LINE** button to select the desired function, and then execute the selected function by pressing and hold the **FEED/LINE** button for more than 3 seconds.
- When the desired interface is selected, this setting will be valid by restarting the printer.
- When HEX dump mode is selected, the printer will be set to this mode only once by restarting the printer.
- When download mode is selected, the printer will be reset automatically and enters the desired download mode.
- When the default setting mode is selected and executed, the printer will be set to default setting.
- Make sure that the function execution is complete (indicator: Solid green light) before turning off the printer.

3.6 PROGRAM DOWNLOAD MODE

In this mode, the printer is set to receive an application program from the host computer to download into its memory. Remember to set the printer to the correct active interface to be used for the data transfer.

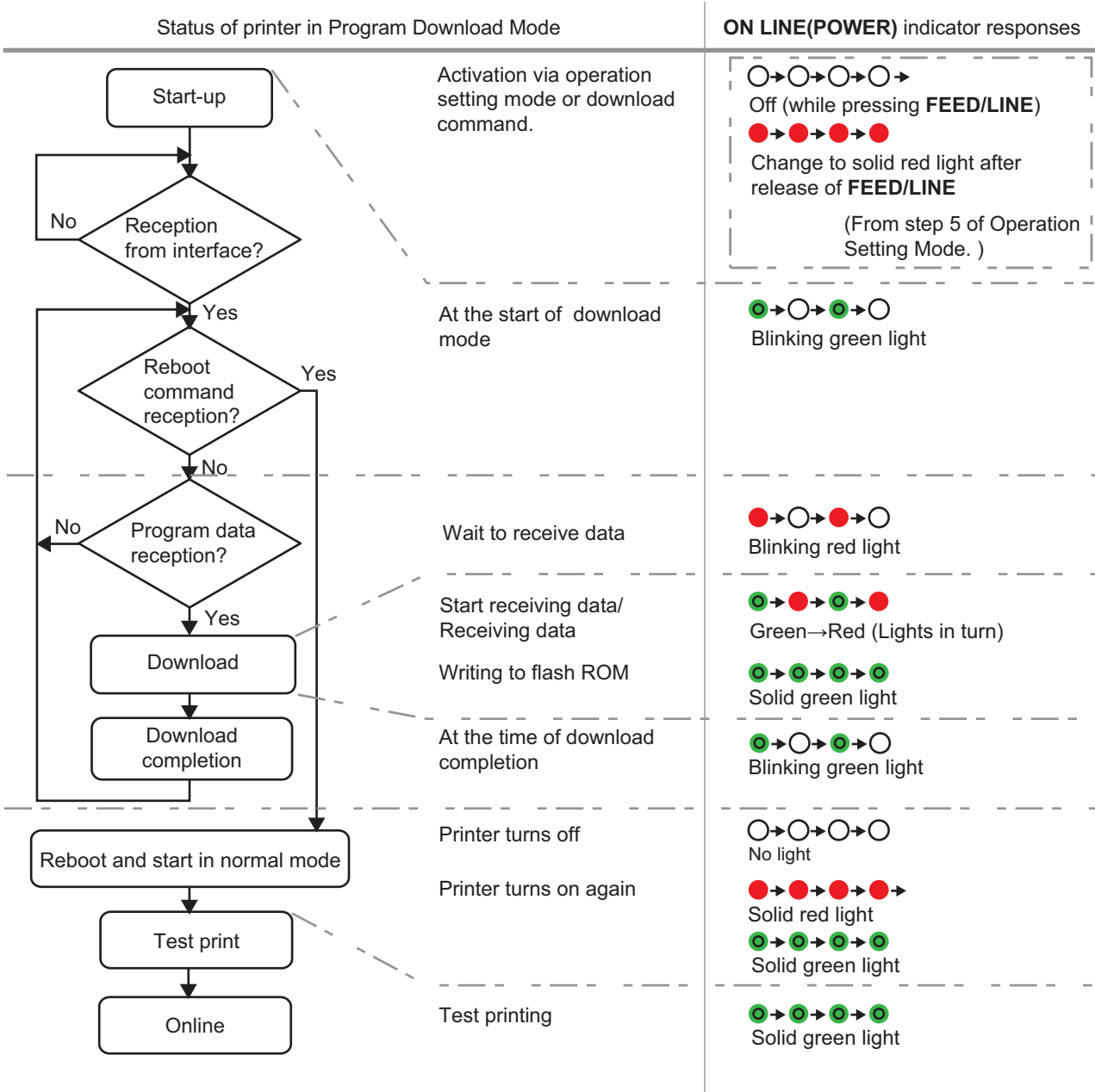

3.6 PROGRAM DOWNLOAD MODE (cont'd)

 **Caution**

- Downloading firmware will initialize all the previous settings (set by Utilities tool application or by commands). Write down its setting details or keep a copy of FACTORY TEST PRINT for your information in case you wish to maintain the same settings in the future.
- DO NOT turn the printer OFF when data is transferring to the flash ROM in Program or Boot Download mode, as it may corrupt the firmware and prevent the printer from starting up correctly

Notes:

- Use the selected interface for PC connection.
- Restart the printer in order to activate the Downloaded program. When starting the printer in normal mode for the first time, the 1st print-out of factory test print will be printed. If no media is set in the printer, the printer will have a paper end error.
- Downloading LAN firmware for USB+RS-232C board will result in download data error.
- When not receiving reboot command, reboot the printer manually and restart in normal operation mode.
- Make sure to check the status of “Wait to receive data” (blinking red light) before turning off the printer manually.
- During the process of downloading, if **ON LINE(POWER)** indicator responses differently from above mentioned procedure, error may be occurred. Please refer to **Section 3.11 Error Occurrence While Downloading** for details.

3.6.1 Firmware Download

The following listed the downloadable firmware according to the connected interface.

Interface	Targeted firmware			
	Printer firm-ware	Onboard LAN firmware	Wireless LAN firmware	Keypad firm-ware
RS-232C	○	–	x	–
USB	○	○	–	○
Onboard LAN	○	○	–	–
Wireless LAN	○	–	○	x
SD card for Keypad	x	–	x	○

○: Downloadable x: Undownloadable –: Not available

3.7 FONT DOWNLOAD MODE

In this mode, the printer is set to download fonts from the host computer. Remember to set the printer to the correct active interface to be used for the data transfer.

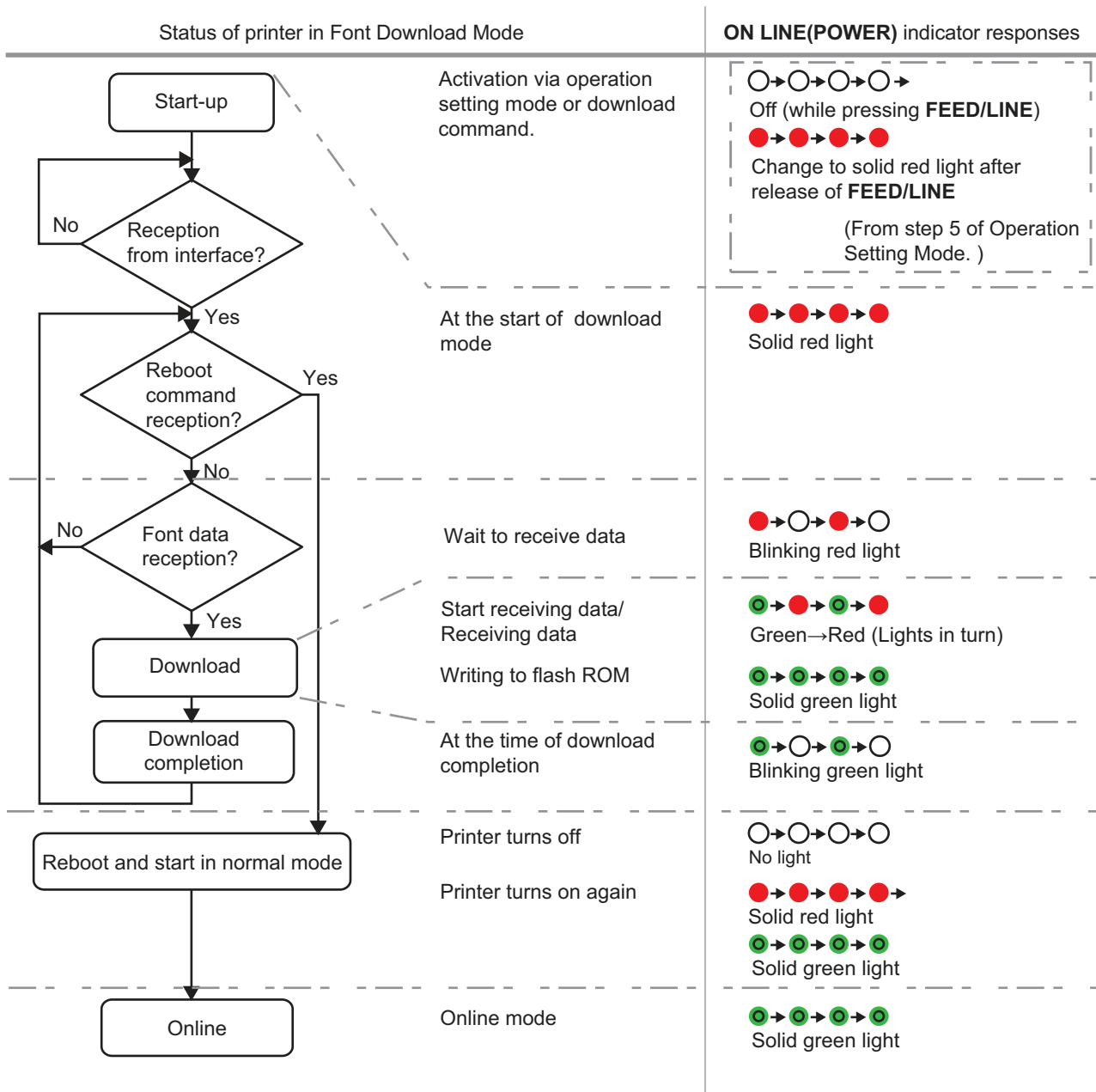

Notes:

- Use the selected interface for PC connection.
- Downloaded font becomes effective by restarting the printer.
- When not receiving reboot command, reboot the printer manually and restart in normal operation mode.
- Make sure to check the status of “Wait to receive data” (blinking red light) before turning off the printer manually.
- During the process of downloading, if **ON LINE(POWER)** indicator responses differently from above mentioned procedure, error may be occurred. Please refer to **Section 3.11 Error Occurrence While Downloading** for details.

3.8 DEFAULT SETTING MODE

When default setting mode is selected and executed in Operation Setting mode (refer to **Section 3.5 Operation Setting Mode**), the printer will be reset to the default setting (factory preset) as listed below.

No.	Items to be reset	Default value	
1	Offset (V, H)	Vertical = 0dot, Horizontal = 0dot	
2	Pitch Offset	0dot	
3	Cut Offset	0dot	
4	Dispensing Offset	0dot	
5	Tear-Off Offset	0dot	
6	Label Size	Pitch 4800dot x Width 448dot [203dpi] Pitch 4800dot x Width 672dot [305dpi]	
7	Print Speed	75mm/sec (3 Inches/sec)	
8	Print Darkness	5A	
9	Sensor Type	Gap	
10	Kanji Code	JIS	
11	Paper End Search	Roll	
12	Zero Slash	Enabled	
13	Proportional Pitch	Enabled	
14	Initial Feed	Disabled	
15	Auto Feed	Disabled	
16	Operation mode	Continuous	- (No setting)
		Tear Off	- (No setting)
		Cutter	Mode 1 (Head position)
		Dispenser	Mode 1 (Head position)
17	Interface	RS-232C	Baud rate=19200bps, Data bit=8bit, Parity=None, Stop bit=1bit, Protocol=Protocol for driver
		LAN	Protocol for driver (ENQ response mode) *1
		USB	- (No initial setting)
18	Tear Off Waiting Time	1000ms	
19	Head Check Range	Normal range (Entire print area)	
20	RFID Mode	Disabled	

*1. To be connected by Port1024 and Port1025 (2 port connections) or Port 9100 (1 port connection)

Note:

LAN and Wireless LAN setting items cannot be reset to factory default even with the default setting mode.

3.9 HEX DUMP MODE

HEX Dump Mode allows you to print the contents of the receive buffer in a hexadecimal format. This feature allows the data stream to be examined for errors and troubleshooting.

After selecting the HEX Dump Mode in Operation Setting Mode, restart the printer (refer to **Section 3.5 Operation Setting Mode**). The printer then awaits data feeds and when data arrives, it prints out the HEX data continuously.

































To exit the HEX Dump Mode, restart the printer by turning off the printer and then on again.

3.10 PRINT MODE OF WIRELESS LAN SETTING

This mode produces print-out for wireless LAN setting. This is only available when the optional wireless LAN interface unit is connected to the printer.

Preparation:

Make sure the media or ribbon (if require) are properly loaded into the printer.

Procedures	Printer status	ON LINE (POWER) indication
1 While pressing FEED/LINE button, press POWER button	Printer start-up	 → Solid red light
2 Release POWER button and keep holding FEED/LINE button. (The printer will cyclically advance to next mode as long the FEED/LINE button is kept holding.)	User Test Print Mode. ↓ Factory Test Print Mode ↓ Operation Setting Mode. ↓ Wireless LAN Setting Print Mode.	 →  →  →  → Solid green light ↓  →  →  →  → Solid red light ↓  →  →  →  → Blinking green light ↓  →  →  →  → Blinking red light
3 Release FEED/LINE button when ON LINE (POWER) indicator changes to blinking red light.	Wireless LAN Setting Print mode activated and enters to print pause mode.	 →  →  →  → Blinking red light  →  →  →  → Blinking green light
4 Press FEED/LINE button to start printing.	Wireless LAN Setting Print start after initial feed and print continuously.	 →  →  →  → Solid green light
Press FEED/LINE button to pause the test printing. Press again to resume.	Wireless LAN Setting Print paused.	 →  →  →  → Blinking green light

3.10 PRINT MODE OF WIRELESS LAN SETTING (cont'd)

Notes:

- If you miss out the chance of releasing the **FEED/LINE** button in step 3 above, just keep holding the **FEED/LINE** button and wait for the next cycle.
- If you released the **FEED/LINE** button at the wrong **ONLINE(POWER)** indication, just turn off the power and restart the procedure again.
- The printer will continuously print the wireless LAN setting information until the **FEED/LINE** button is pressed. The printing is paused and will resume printing if the **FEED/LINE** button is press again.

To terminate the Wireless LAN Setting Print mode

First, make sure to press the **FEED/LINE** button to pause the test printing, then press **POWER** to turn off the printer.

3.10.1 Output Data of the Wireless LAN Settings

The output data of the Wireless LAN Settings shows the current settings of the printer. These output data are printed out in 2 pieces, with the media size of 60mm[2.36"] (Width) x 80mm[3.15"] (Pitch), Standard.

First print-out (Basic settings)

No.	Print Item		Contents of the print data
1	Interface 1	Interface 1(W-LAN)	WIRELESS LAN
2	WLAN Ver/Date	WLAN module F/W version, Creation date	**.** / YY.MM.DD
3	Buffer Type	Buffer type	Multi
4	Protocol	Protocol	Driver(CYC) Driver(ENQ) Status3
5	MAC Address	MAC address	**.*.*.*.*.*.*.*
6	IP Address	IP address	000.000.000.000 ~ 255.255.255.255
7	Subnet Mask	Subnet mask	000.000.000.000 ~ 255.255.255.255
8	Default Gateway	Default gateway	000.000.000.000 ~ 255.255.255.255
9	DHCP	DHCP	ON OFF(Auto-IP) OFF
10	RARP	RARP	OFF ON
11	W-LAN Mode	Wireless LAN mode	Ad hoc Infrastructure(SSID)
12	SSID	SSID	1 to 32-chr string
13	Channel	Channel	1 to 11
14	Security Mode	Security type	OFF WEP WPA WPA2 DynamicWEP

Second print-out (Detailed settings)

No.	Print Item		Contents of the print data
1	WLANAuthentication	Wireless LAN authentication function	OpenSystem SharedKey
2	WEPKey1	WEP key 1	(*1)
3	WEPKey2	WEP key 2	(*1)
4	WEPKey3	WEP key 3	(*1)
5	WEPKey4	WEP key 4	(*1)
6	WEPKeyIndex	WEP key index	1 to 4
7	WPAAuthentication	WPA/WPA2 authentication function	PSK EAP(IEEE802.1X)
8	WPAPSKMode	WPA/WPA2 encryption method	TKIP AES
9	WPAPSK	Pre-shared key	(*1)
10	EAPMode	EAP authentication function	EAP-LEAP EAP-TLS EAP-PEAP EAP-TTLS NONE
11	EAPUserName	EAP authentication user name	(*1)
12	EAPPassword	EAP authentication password	(*1)
13	EAPCertKeyPassword	EAP secret key password	(*1)
14	FtpDiscTimeout	FTP time-out duration	30 to 500 s
15	RawDiscTimeout	Socket connection time-out duration	0 to 3600 s
16	LpdDiscTimeout	LPD time-out duration	30 to 500 s

(*1) "####" will be printed on a label when passwords are set.

3.11 ERROR OCCURRENCE WHILE DOWNLOADING

The following are the possible causes of errors in program/font download.

- (1) The flash ROM may be in a state that fails to permit data being written to it.
- (2) Incorrect data is received while transferring download data.

3.11.1 Operation Status when having an Error in Downloading Process

The **ONLINE(POWER)** indicator responses when having an error in downloading process is as follows.

Operation status	ONLINE(POWER) indicator
Flash ROM error	Solid red ●→●→●→●
Download data error	Red x 4 times --> off (Longest blink interval) ●→●→●→○→○→○→○



Caution

- Make sure that you do NOT turn the printer OFF when data is transferring to the flash ROM in Program or Boot Download mode, as it may corrupt the firmware and prevent the printer from starting up correctly.
- Make sure to check the printer status when downloading, and do not turn off the printer during download.
- Ensure that the printer is running on a stable power supply during such flash ROM writing operations.

3.12 PRINT HEAD CHECK

3.12.1 About Head error and Release Method

The head check function detects the integrity of the heating elements in the thermal print head.

In CG2 series printer, the **head check range** is set as **normal (Entire print area)** at default. Use the head check command (ESC+HC) to set the **head check range** either **entire print area** or **barcode print area**.

When a head error occurred, the **ONLINE(POWER)** indicator lighted red. After detection of a print head error, use a scanner to check all affected labels.

At this moment, when the **head check range** is set as **Entire print area**, press the **FEED/LINE** button more than five seconds to change the **head check range** to **barcode print area** and see if printing can be resumed normally. If printing resume, the print head faulty does not fall on the barcode area for the current print job. As such, printing may be continue but with degraded print quality and readable barcode.

If the head check error still occurs and the current print job has to be complete, the printing can be forced to resume by holding down the **FEED/LINE** button for more than five seconds. The printer goes in offline state when the head error is released. Once the head error is released, the head check function will be disabled until the printer is turned off. Please read the Attention below before you proceed this operation.

ATTENTION:

Although restricting the **head check range** to **barcode print area** allows you to continue printing, or forcing the printer to resume printing, you should only do so in order to complete an urgent print job. Check the printed labels to make sure the output is usable in spite of the head error. As soon as possible, stop using the print head to prevent further damage. If necessary, get the print head replaced.

Notes

- As for the labels issued after having a head error, check the print quality and perform reading of barcode by scanner. As soon as possible, stop using the print head to prevent further damage. If necessary, get the print head replaced.
- The head check range (Barcode print area) is valid for the barcodes printed by the barcode specification command such as (ESC+B, ESC+D, ESC+BD). As for the graphic data with barcode, select the head check range (Entire print area).

3.12.2 Head Check Range (Entire Print Area)

When the **Entire print area** is selected for **head check range**, the head check will be performed within the minimum and maximum horizontal print area regardless of print contents (e.g. font, barcode, graphic).

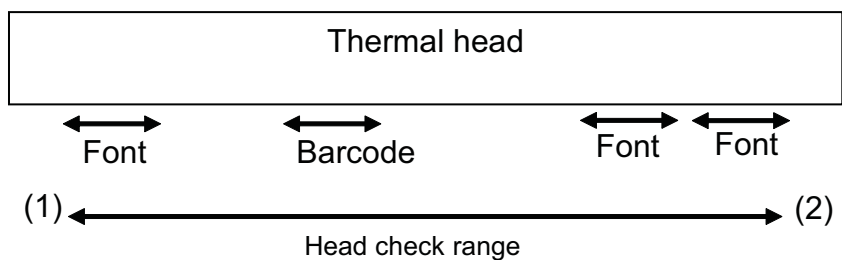

* The head check will be performed within the minimum and maximum horizontal print area (between (1) and (2)) regardless of print contents.

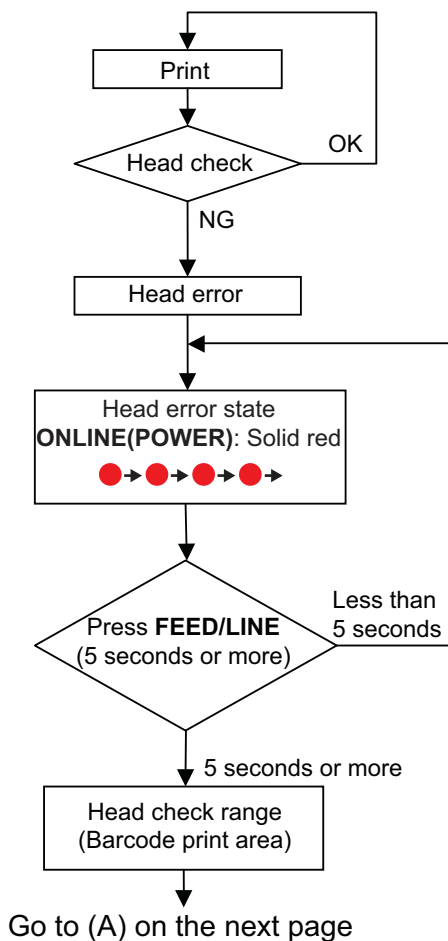

Notes

- When the **head check range** is changed from **entire print area** to **barcode print area**, the **barcode print area** will still be valid even after turning off the printer.
- To change the **head check range** from the **barcode print area** to the **entire print area**, use the head check command (ESC+HC) to select the **entire print area** or execute either **default** or **factory clear**.

3.12.3 Head Check Range (Barcode Print Area)

When the **Barcode print area** is selected for the **head check range**, the head check will be performed in the area which barcode is printed.

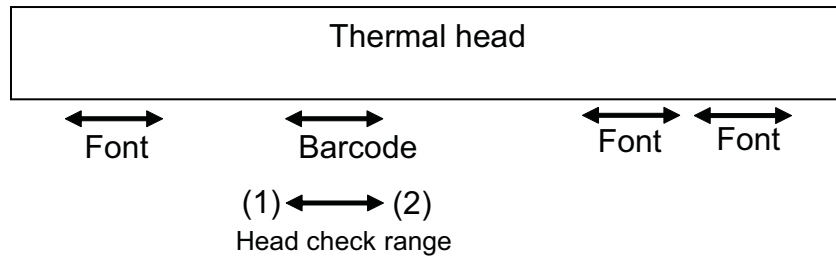

* The head check will be performed in the barcode print area between (1) and (2) only.

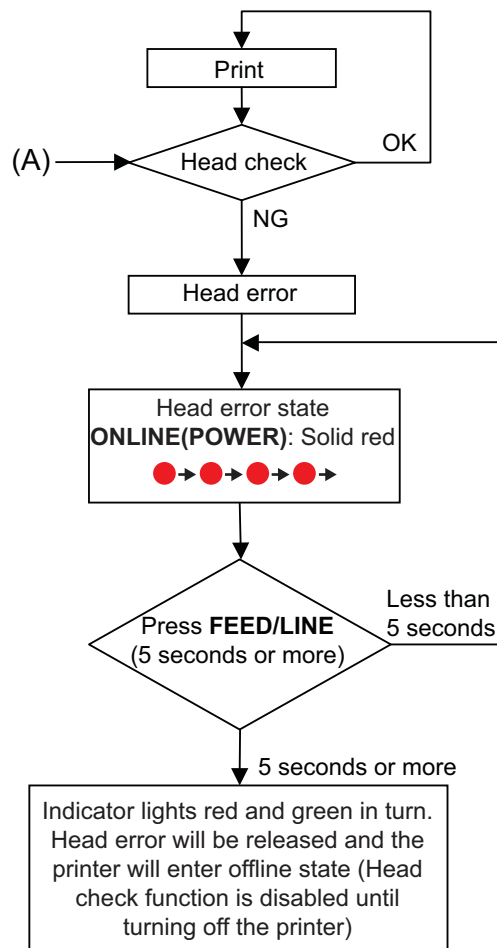

3.13 PRINTER CONFIGURATIONS SETTING

You can set the printer configuration by sending commands from the host computer or by using the Utilities Tool application provided (SATO Accessory CD-ROM).

No.	Category	Setting item	Setting contents
1	Operation mode	Print speed	50mm/s to 100mm/s
2		Cutter mode	Head position/Cut position/No backfeed
3		Dispenser mode	Head position/Peel off position
4		Print darkness	A to C
5		Print darkness level	1 to 5
6		Sensor type	I-mark/Gap/Sensor-off/Gap 2 (for wrist band)
7		Zero slash	Yes/No
8		Kanji code	JIS code/SJIS code
9		Label type	Adhesive label/Non-adhesive tag
10		Initial feed	Enabled/Disabled
11		Character pitch	Proportional/Fixed
12		Head check	Normal/Barcode
13		Option Waiting time	5 to 200 (×100ms)
14	Media size	Pitch	1 to 4800 dots (including liner/backing paper) [CG208TT/DT] 1 to 4800 dots (including liner/backing paper) [CG212TT/DT]
15		Width	1 to 448 dots (including liner/backing paper) [CG208TT/DT] 1 to 672 dots (including liner/backing paper) [CG212TT/DT]
16	Base reference point	Vertical print position offset	±396dot
17		Horizontal print position offset	±396dot
18	Offset setting	Continuous mode	±99dot
19		Tear Off mode	-60dot to +99dot
20		Cutter mode	±99dot
21		Dispenser mode	±99dot
22	RS-232C interface *1	Baud rate	9600/19200/38400/57600/115200bps
23		Data bit	7/8 bit
24		Parity	No parity/Odd number/Even number
25		Stop bit	1/2 bit
26		Control	READY/BUSY control (single item buffer), READY/BUSY control (multi buffer), Xon/Xoff, Protocol for driver(STATUS4), STATUS3

Section 3: Operation and Configuration

No.	Category	Setting item	Setting contents
27	LAN interface *2	LAN mode	Protocol for driver(STATUS4)Cyclic response *3 Protocol for driver(STATUS4)ENQ response *3 1 port connection/ENQ response(STATUS3)
28	Non-standard code	Nonstandard code switching	Standard code/Nonstandard code
29		Nonstandard code setting	Nonstandard code settings for STX, ETX, ESC, ENQ, CAN, NULL, OFFLINE
30	Download	Firmware download	Download firmware from the host computer.
31		Reboot mode *4	(1) Start up in program download mode (Available in normal operation mode only) (2) Start up in normal operation mode (Available in program download mode only)

*1. Available for USB+RS-232C specification only.

*2. Available for USB+LAN specification only.

*3. Use SATO port or Port 9100 when sending print request from the printer driver.

*4. The printer will restart in specified mode.

3.14 HEAD OVER-TEMPERATURE PROTECTION

When the head temperature exceeds 70 °C (158 F), the head over-temperature protection will be activated and the print operation will be paused until the temperature drops down to 55 °C (131 F).

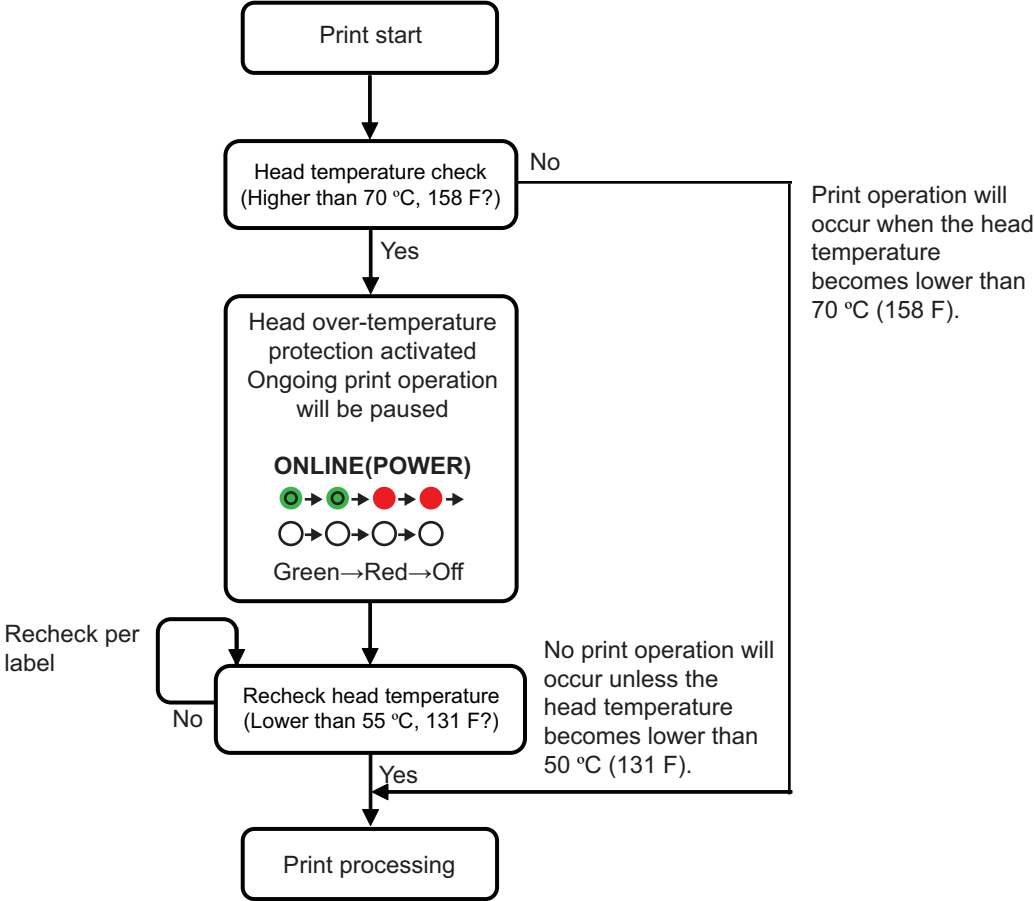

* Head temperature will be checked per label.

3.15 PROTECTION FUNCTION WHEN USING AC ADAPTER

When the print ratio per label exceeds the ratio shown in the table below, print job is paused temporarily because of protective function.

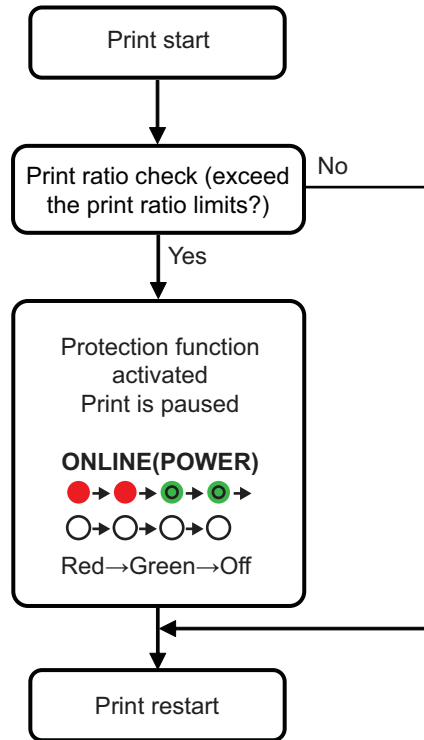

- The protection function (pause function) will be activated when the print ratio exceeds the ratio listed in the table below.

Model	Print speed		
	2 inch/sec	3 inch/sec	4 inch/sec
CG208DT/TT	44%	35%	31%
CG212DT/TT	43%	38%	36%

- Print pause duration differs depending on print ratio, print speed and pitch size. The table below shows the pause duration when the print speed is 3 inch/mm and the pitch size is 80mm.

Model	Print ratio				
	40%	50%	60%	70%	80%
CG208DT/TT	120 ms	417 ms	713 ms	1010 ms	1307 ms
CG212DT/TT	55 ms	335 ms	615 ms	896 ms	1176 ms

3.16 MEASURES FOR RFID ERROR

If the number of tag write/read failures exceeds the maximum retry counts specified in [RFID tag error ignore counts] or [Retry counts], the printer will indicate an error with **ONLINE(POWER)** indicator blinking red and pause to wait for key entry.

To restart the print, refer to the following operations.

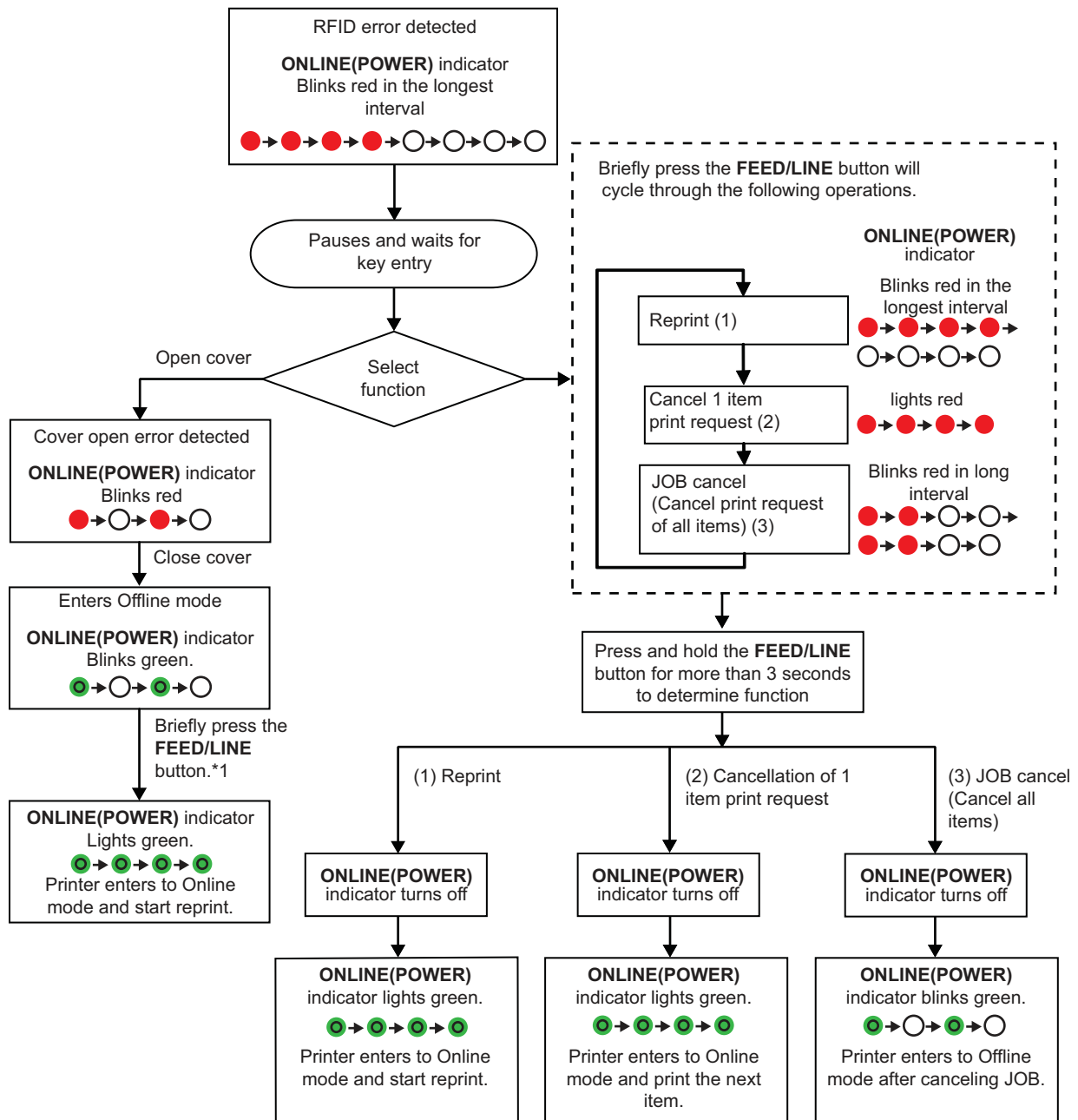

Notes:

- If a “RFID tag error” is detected, the tag will be void and marked as a defected tag.
- After performing the initial feed by the **FEED/LINE** button, the reprint will be performed.*1

This page is intentionally left blank

4

TROUBLESHOOTING

If you are unable to produce printouts on the CG2 series printer, use this section to make sure the basics have been checked, before deciding you are unable to proceed any further.





This section is divided into four parts:

- 4.1 Error signal troubleshooting
- 4.2 Troubleshooting table
- 4.3 Interface troubleshooting
- 4.4 Test print troubleshooting

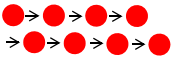
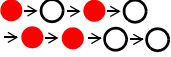
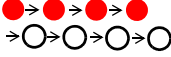
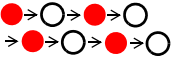
4.1 ERROR SIGNAL TROUBLESHOOTING

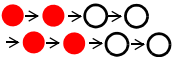
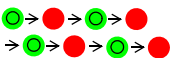
The **ON LINE(POWER)** indicator lights or flashes in different color as listed below to alert user of the error occurred on the printer. [Indicator sequence (as shown from left to right): ○Off, ●Solid red light, ●Solid green light]

Item	Contents	ONLINE (POWER) LED	Causes	Corrective Actions
Hardware error	FLASH ROM error	Solid red 	1) FLASH ROM read/ write error. 2) Exceeded the FLASH ROM write count limits.	1), 2) Board replacement
	Setting information (FROM) error		1) FLASH ROM read/write error. 2) Exceeded the FLASH ROM write count limits.	1), 2) Board replacement
	Kanji data (FROM) error		1) FLASH ROM read/write error. 2) Exceeded the FLASH ROM write count limits.	1), 2) Board replacement
	Machine error		1) Board defect	1) Board replacement
	Head error		1) Print head is damaged (Print head burnout).	1) Replace print head or disable head check function.
Program error	Incorrect program error		1) Download did not complete successfully.	1) Download again
Communication error	Communication error by kit	[Red->Off] x twice ->Red x twice->Off (blinks with changing interval) 	Error contents may vary depending on the kit installed.	
	Buffer over		1) Received the amount of data exceeding the limit of receive buffer. 2) Wrong protocol.	1) Correct the software on the host side. 2) Set the correct protocol.
	RFID error		1) RFID write error. 2) Wrong protocol for RFID.	1) Reset the paper. 2) Set the correct protocol.
Download error	Download error		1) Downloaded wrong data. 2) Downloaded LAN firmware to USB+RS-232C board.	1) Download again. 2) No need to download LAN firmware to USB+RS-232C board.
Minor error	Cover open	Blinking red 	1) Cover is not close properly.	1) Close the cover.
	Sensor error		1) Wrong sensor level. 2) Wrong sensor type. 3) Label meandering.	1) Level adjustment. 2) Sensor type adjustment.
	Paper end		1) Out of paper.	1) Set the paper properly.
	Ribbon end		1) Out of ribbon or ripped ribbon. 2) Ribbon is not set properly.	1) & 2) Set the ribbon properly.

Item	Contents	ONLINE (POWER) LED	Causes	Corrective Actions
Option	Cutter	Red x twice ->Off (blinks in long interval) 	1) Cutter is not connected. 2) Cut operation was not performed successfully.	1) Connect the cutter unit. 2) Set and feed the paper again.
Warning	Buffer near full	Green -> Red (Lights in turn) 	1) Free space for receive buffer is low.	1) Pause the data transmission on the host side and wait to have enough buffer space.
	Ribbon near end	Green-> Red ->Off (Blinks in turn) 	1) Remaining amount of ribbon is little.	1) Ribbon replacement.
	Head over-heat protection	Green -> Red -> Off 	1) Goes over the limit of print head temperature.	1) Automatically recovers when print head temperature drops down to 55°C and below.
	AC adapter protect	Red-> Green -> Off 	1) Going over the maximum print ratio.	1) Automatically recovers after pausing a certain period of time.

4.2 TROUBLESHOOTING TABLE

TROUBLESHOOTING TABLE	
NO POWER	
Printer does not turn on.	Power connector or AC adapter is not properly connected.
NO LABEL MOVEMENT	
Media is not set properly.	Set media and media guide correctly
Incorrect label sensor selected.	Set the sensor correctly by printer setting tool.
Dirty platen roller.	Clean the platen roller.
Damaged platen gear.	Replace platen roller and gear.
INCORRECT LABEL POSITIONING	
Incorrect label sensor selection.	Set the sensor correctly by printer setting tool.
Improper sensor adjustment.	Adjust sensor sensitivity as required.
Data input error.	Ensure correct data stream.
Incorrect offset settings.	Adjust settings as required.
NO PRINT MOTION	
The interface cable is not properly connected.	Connect the interface cable.
Interface problems.	Troubleshoot interface - refer to the next section.
Data input error.	Ensure correct data stream.
Defective main circuit board.	Replace main board by SATO authorised servicing personnel.
PRINTER CREATES A BLANK LABEL	
Data input error.	Ensure correct data stream.
Incorrect label sensor selection.	Set the sensor correctly by printer setting tool.
Print head is disconnected.	Power off the printer and ensure a proper connection.
Defective print head.	Replace print head as required.
Defective main circuit board.	Replace main board by SATO authorised servicing personnel.
IMAGE VOIDS	
Dirty print head.	Clean print head.
Defective print head.	Replace print head.
Defective main circuit board.	Replace circuit board by SATO authorised servicing personnel.
Damaged or worn platen roller.	Replace platen roller.
Poor label quality.	Use higher quality media. Use only SATO-certified media.
Ribbon stock and media are mismatched. *1	Consult with media supplier. Use only SATO-certified media.
RIBBON WRINKLING *1	
Damaged or worn platen roller.	Replace platen roller.
Foreign material on print head and/or platen roller.	Clean as required.
Foreign material on labels.	Use higher quality media. Use only SATO-certified media.
Defective print head.	Replace print head as required.

*1 Ribbon stock conditions are only applicable to CG208TT and CG212TT printer.

TROUBLESHOOTING TABLE	
LIGHT PRINT IMAGES	
Low print head darkness.	Adjust darkness level setting.
Foreign material on print head.	Clean print head and platen roller.
Excessive print speed.	Reduce print speed setting.
UNEVEN PRINT DARKNESS	
Damaged or worn platen roller.	Replace platen roller.
Dirty print head.	Clean print head.
Defective print head.	Replace print head as required.
SMEARED PRINT IMAGES	
Poor media quality	Use higher quality media. Use only SATO-certified media.
Foreign material on print head and platen roller	Clean print head and platen roller.
Foreign material on labels	Use higher quality media. Use only SATO-certified media.
Excessive print head energy	Adjust darkness level setting.
Excessive print speed	Adjust print speed as required.
MEANDERING MEDIA	
Incorrectly loaded media.	Ensure correct loading.
Media is not set properly.	Set media and media guide correctly.
Damaged or worn platen roller.	Replace platen roller.

4.3 INTERFACE TROUBLESHOOTING

This chapter provides a checklist for the various interface types. Locate the checklist relative to the interface used and perform each of the troubleshooting tasks until the problem has been isolated.

UNIVERSAL SERIAL BUS (USB) INTERFACE	
If nothing prints during a test print, verify the device drivers have been successively installed by performing the following:	
CHK	TROUBLESHOOTING STEP
	Click on Start, Settings, and then Control Panel.
	Click on System within the new window.
	Click on the Device Manager tab.
	Ensure that the View Device By Type is checked.
	Scroll to SATO-USB Device and ensure that errors do not exist. Reinstall as required.
	Reboot the PC and the printer.

RS232 SERIAL INTERFACE	
CHK	TROUBLESHOOTING STEP
	Ensure the correct interface module is correctly installed. Run self-test to verify.
	Ensure the serial cable (Null Modem) meets specifications and is correctly connected at each end.
	Ensure the serial cable is not defective.
	Ensure the communication parameters for the baud rate, parity, data bits and stop bits are consistent with those being sent from the host computer.
	Ensure the printer is receiving information from the computer using the Receive Buffer Hex Dump mode. Refer to that procedure within this manual for instructions. The command stream should be continuous and possess 0Dhex and/or 0Ahex (carriage return and line feed) characters throughout. However, there should not be either located between the start (<ESC>A) and the stop (<ESC>Z) commands.
	Try another port to isolate the problem.
	Replace the main circuit board if determined to be the problem.

LAN ETHERNET INTERFACE	
CHK	TROUBLESHOOTING STEP
	Ensure the interface has been correctly configured. Wait two minutes and run self-test to verify. If a test label does not print, there may be a hardware problem.
	Ensure the cable and its ports are not defective.
	Ensure that a faulty print server or other protocol related scenarios are not creating a queue setup issue. Systematically perform checks and tests to isolate the cause.
	If using TCP/IP, ensure a valid IP address is specified and that all parameters are correct (subnet mask, gateway, etc.). Attempt to PING the IP address assigned to the network interface.
	If using a repeater or hub, ensure the SQE is turned off. Also ensure the repeater port is not defective by trying the print server on another port.
	Install the IPX/SPX protocol on a workstation to determine if the network device can be discovered via the MAC address. If able, configure the appropriate protocols and retest connectivity.
	Use a crossover cable to isolate the printer from the network by connecting from the interface and workstation. Verify that the parameters match on each. Test connectivity.

WIRELESS LAN INTERFACE (OPTIONAL)

CHK	TROUBLESHOOTING STEP
	Ensure the antenna is properly and completely installed.
	Ensure the wireless LAN unit is properly installed.
	Ensure the green connection lights on the back of the interface board are illuminated.
	If not obtaining an IP address, check the SSID or encryption and ensure those were properly entered.

4.4 TEST PRINT TROUBLESHOOTING

Chapter provides instruction on special printing to identify and resolve specific print problems.

4.4.1 Hex Dump

Allows the operator to determine if there were problems in the downloading of data. The contents of the print buffer can be examined using the Hex Dump Mode. In the left column, each line of data received is numbered. The center column provides the data in hexadecimal format. And in the right column, same data is provided in the ASC II format. Refer to **Section 3.9 HEX Dump Mode** for more details to perform this activity.

4.4.2 Test label printing

Allows the operator to identify specific problems regarding mechanical performance and setup. The test label is designed to assist in the identification of print problems. Refer to **Section 3.3 User Test Print Mode** for more details to perform this activity.

This page is intentionally left blank

5

CLEANING AND MAINTENANCE

This section provides information on user maintenance for the CG2 series printer.

The following information is covered here:

- 5.1 Cleaning The Print Head, Platen and Rollers
- 5.2 How To Clean The Printer (Cleaning Kit)
- 5.3 How To Clean The Printer (Cleaning Sheet)
- 5.4 Easy Replacement of Parts
- 5.5 Adjusting Print Quality



Caution

- When cleaning the print head, bear in mind that the print head and its surrounding maybe hot. Wait till the printer cool down before proceed cleaning.
- Be sure to turn off the power before cleaning.
- The suggested cleaning schedule here are just guidelines. If necessary, clean as appropriate depending on the degree of contamination.
- Use a cleaning pen, cotton swab or cotton cloth, from an approved cleaning kit, to clean the printer units.
- Use only soft, lint-free materials for cleaning. Avoid using hard objects for the cleaning process, as they will damage the components.

5.1 CLEANING THE PRINT HEAD, PLATEN AND ROLLERS

The print head not only generates printouts of barcodes, but also graphics and text. To produce optimal printing, it must be kept clean in spite of the dirt and adhesive that constantly accumulates on its print surface. Furthermore, dirt can accumulate along the label path, affecting parts like sensors and guides, and reducing their performance.

Therefore, it is important to clean these important components periodically. The printer cleaning kit and cleaning sheets can be purchased from your authorized SATO representative.

When to clean with a cleaning kit

- ◆ For the printer head, platen roller, paper sensor, and label guide: clean after using up every other roll of media.
- ◆ For other parts: clean after finishing every six rolls of media.

When to clean with the cleaning sheet

- ◆ For printer head: clean after using every six rolls of media, or when you found any burned glaze on the surface of the print head.

5.2 HOW TO CLEAN THE PRINTER (CLEANING KIT)

If you are using a carbon ribbon, be sure to remove it before cleaning. Follow the instructions supplied with the cleaning kit. Use the items to clean the following parts.

1. Before starting, get ready an approved cleaning kit from your SATO representative. Make sure the printer is power off, and remove the power cable.
2. Lift up the **Top Cover**.
3. Remove the media and the ribbon.

Cleaning the Print Head

4. Apply **Thermal Print Head Cleaner** to a cotton swab.
5. Locate the **Print Head Assembly** which is mounted under the Top cover. The **Print Head** faces downward along the front edge of the assembly. Pass the end of the dampened swab along the entire width of the **Print Head**.
6. Check for any black coloring or adhesive on the swab after cleaning.
7. Repeat if necessary until the swab is clean after it is passed over the print head.

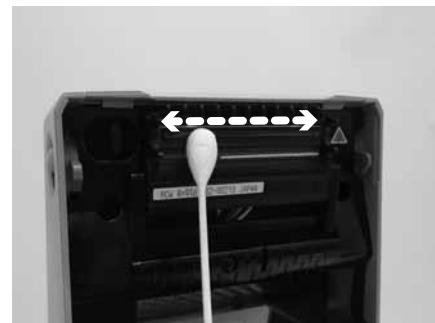

Cleaning the platen roller, sensor and label guide

8. The **platen roller** is the black rubber roller near the front panel. Wet some cotton swabs or cotton cloth with cleaning solution. While rotating the **platen roller** with your fingers (see arrow), clean the entire length of the roller using one or more cotton swabs. Wipe any dirt or accumulated adhesive off the **platen roller**.

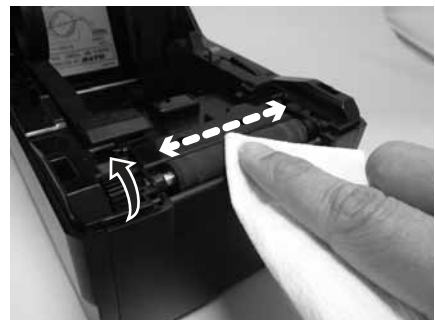

5.2 HOW TO CLEAN THE PRINTER (CLEANING KIT) (cont'd)

9. Locate the **I-mark sensor** on the left **Media guide**, **Gap sensor** in the middle of media path and near the **print head**. (See figures on the right).
10. Dabbed a cotton cloth with the cleaning solution, clean any foreign matter from the exposed surface of the **media guides** and **sensor**. Inserting the cotton cloth in the slot of the media guide and briskly cleaning it with a back and forth motion.
11. Repeat the whole cleaning process when it is necessary. The **platen roller** should be cleaned whenever foreign matter such as dust or adhesive is present.

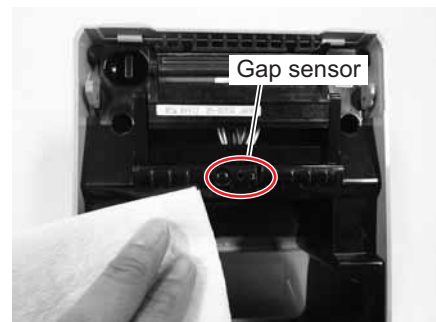
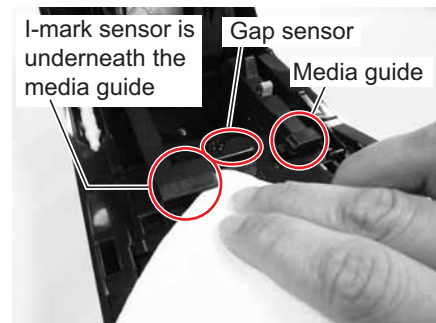

5.3 HOW TO CLEAN THE PRINTER (CLEANING SHEET)

If certain stains on the print head cannot be removed easily with cotton swabs dabbed in cleaning solution, the cleaning sheet is used for clearing such stubborn debris on the print head.

1. Make sure the printer is power off and remove the power cable.
2. Lift up the **Top Cover**.
3. Remove the media and the ribbon.
4. Place the head **cleaning sheet** between the **print head** and the **platen roller**. The coarse side of the **cleaning sheet** should face the surface of the **print head** elements.
5. Close the **top cover** with approximate 25mm (1 inch) of the **cleaning sheet** extended out of the printer.
6. Using both hands, slowly pull the exposed **cleaning sheet** outwards. This will remove any dirt stuck to the **print head**.
7. When the **cleaning sheet** has been removed, perform steps 2 to 6 to repeat the cleaning procedure one or two more times.
8. When no more additional dirt appears on the **cleaning sheet** after it has been pulled out, you can stop cleaning with the sheet.
9. Use the **cleaning pen** from the cleaning kit or simply use a cotton swab applied with head cleaner to gently remove any remaining dirt from the **print head**.



5.4 EASY REPLACEMENT OF PARTS

CG2 series printer has a unique user-friendly feature in replacing of print head and platen roller. The one-touch, tool-less print head release mechanism enables the print head to be quickly, easily replaced. Platen roller can be replaced without the need of any tools.

5.4.1 Releasing/ Replacing the Print Head

The print head on the printer is a user-replaceable item. If it becomes damaged for any reason, it can be easily removed and replaced. Contact your local SATO representative for information on obtaining a new print head.

For CG212 DT and CG218 DT Direct Thermal printer

1. Make sure the printer is turn off, and remove the power cable.
2. Lift up the **Top Cover**.
3. Locate the **side tab** (see arrow ①) on the left side of the **print head**. Press and hold down this tab. At the same time, pull the whole **print head assembly** downward.

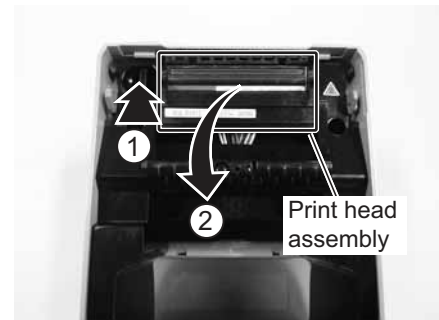

4. The **cable connector** (circled) at the rear of the **print head** is now exposed. Pull the print head downward, then gently disconnect the **print head** from the cable connector.
5. Carefully attach a replacement **print head** to the **cable connector**. The connector is keyed so that it can only be inserted in the correct orientation.



Note:

While handling the **print head**, be careful not to scratch the printing surface of the **print head**. Scratching the surface will cause permanent and irreparable damage that is not covered by the warranty!

6. Reinsert the new **print head assembly** into the printer, making sure that the **slots** at the two sides of the **print head** fit on the **round pivots** of the printer (see circled area).



7. Press and hold down the **side tab** (see arrow ①) which was previously used to release the **print head**. Push the **print head** upwards so that it snaps into place.
8. Release the **side tab** and close the **Top Cover**. Proceed to perform a test print to ensure that the **print head** is connected properly.

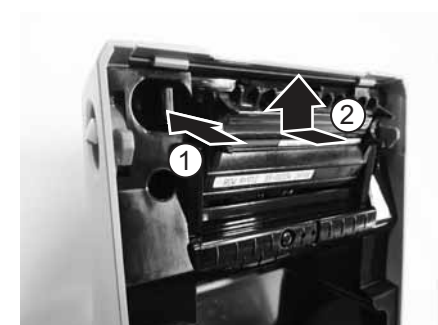

5.4 EASY REPLACEMENT OF PARTS (cont'd)

For CG212 TT and CG218 TT Thermal transfer printer

1. Make sure the printer is turn off, and remove the power cable.
 2. Lift up the **Top Cover**.
 3. Pull the **lever** on the middle of the **ribbon unit** downward to pull out the **ribbon unit**. Then simply let down the **ribbon unit**. There is a stopper midway through its movement range that will prevent the ribbon unit from snapping down.
 4. On the right side of the **ribbon unit**, press the catches at both top and bottom to remove the **cover**. Remove the whole **print head assembly** downward.
 5. The **cable connector** (circled) at the rear of the **print head** is now exposed. Pull the **print head** downward, then gently disconnect the **print head** from the cable connector.
 6. Carefully attach a replacement **print head** to the **cable connector**. The connector is keyed so that it can only be inserted in the correct orientation.
- Note:**
While handling the **print head**, be careful not to scratch the printing surface of the **print head**. Scratching the surface will cause permanent and irreparable damage that is not covered by the warranty!
7. Reinsert the new **print head assembly** into the printer, making sure that the **pivot** at the left side of the **print head assembly** fit to the holes on the **ribbon unit**.
 8. Insert the **cover** back to the **ribbon unit** to fix and hold the **print head** back to position. Proceed to perform a test print to ensure that the **print head** is connected properly.

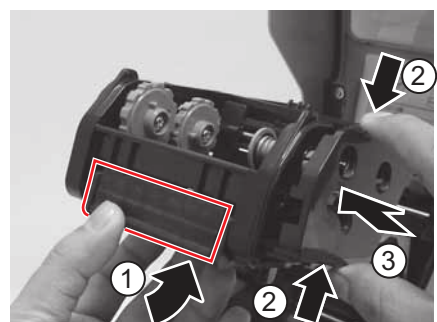
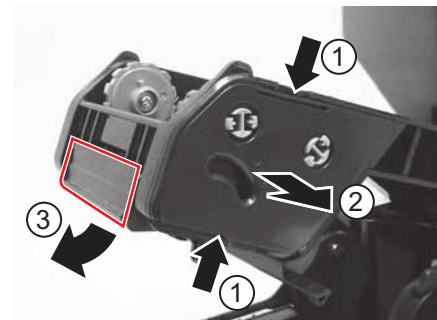
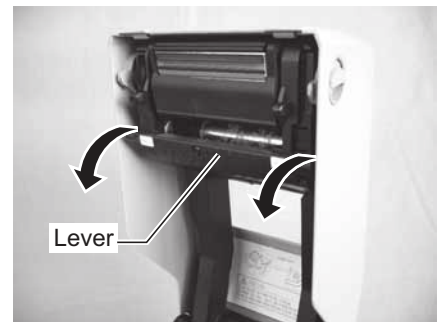

5.4 EASY REPLACEMENT OF PARTS (cont'd)

5.4.2 Releasing/ Replacing the Platen roller

1. Make sure the printer is power off and remove the power cable.
2. Lift up the **Top Cover**.
3. Locate the two **platen bearing** on two sides of the **platen roller** and turn the handles in the direction as shown.
4. Lift up the defective **platen roller** assembly with the handles and replace it with a new one.
5. Reassemble in the reverse order as above. Make sure the **platen bearing** snap back in place. Perform a label feed to ensure the **platen roller** is assembled correctly.

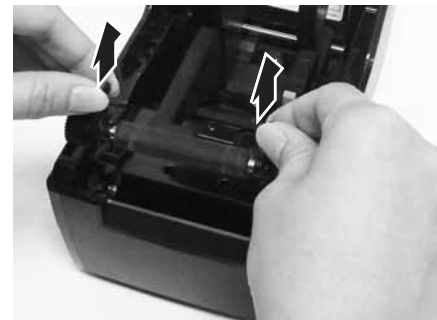

5.5 ADJUSTING PRINT QUALITY

Print quality can be optimized with regular cleaning and maintenance of the print head and components along the label path. Additionally, you can fine-tune print quality by adjusting print darkness and print speed settings.

When adjusting the printer for optimum print quality, a barcode verifier system is highly recommended for evaluating the printouts. The human eye is a poor judge of the relative widths of the bars in a symbol, a characteristic that is extremely important for good bar code quality.

Print Darkness

This adjustment allows the user to control (within a specified range) the amount of power that is used to activate the print head heating elements. It is important to find a proper print darkness level based on your particular label. The printed images should not be too light nor should the edges of text or graphics be smudged. Instead, the edges of each image should be crisp and well defined. The adjustment can be made via standard SBPL commands or by the Utilities Tool application. For more information refer to the SBPL Programming Reference.

Print Speed

The other method of controlling print quality is by controlling the speed at which the label is printed. It is especially critical when printing "ladder" bar codes (bar codes printed with the bars parallel to the print line). When printing a "ladder" bar code, it is important to allow the head to cool sufficiently before stepping to the next position. If it does not have sufficient time to cool, the bar will be "smeared" on the trailing edge. The adjustment can be made via standard SBPL commands or by the Utilities Tool application. For more information refer to the SBPL Programming Reference.

6

GENERAL SPECIFICATIONS

6.1 PRINTER BASIC SPECIFICATIONS

MODEL NAME	CG208 DT	CG212 DT	CG208 TT	CG212 TT
------------	----------	----------	----------	----------

PHYSICAL CHARACTERISTICS				
Width	128 mm (5.04")			
Depth	235 mm (9.25")			
Height	173 mm (6.81")			
Weight	1.5 kg (3.3 lbs.)		1.6 kg (3.5 lbs.)	

POWER SUPPLY (AC ADAPTER)	
Input Voltage	100-240 V AC, +/-10%, 50/60 Hz (Full range)
Output Voltage	19 V DC, +/-5%, 3A
Power Consumption	At peak times: 40 Watts / 60 VA (at 30% printing ratio) During standby: 2.5 Watts / 5.3 VA * With input power voltage conditions: AC 100 V

ENVIRONMENTAL (EXCLUDING MEDIA)	
Operating Temperature	0° to 35°C (32 to 95 F)
Storage Temperature	-10° to 60°C (14 to 140 F)
Operating Humidity	30 to 80% RH, Non-condensing
Storage Humidity	15 to 85% RH, Non-condensing

PRINT				
Method	DT models: Direct Thermal only		TT models: Thermal Transfer and Direct Thermal	
Maximum Speed (selectable)	50, 75 or 100 mm/second 2, 3 or 4 Inches/second (Setting: 2, 3, 4) *Print speed varies depending on the of media used.			
Resolution	8 dots/mm (203 Dots Per Inch)	12 dots/mm (305 Dots Per Inch)	8 dots/mm (203 Dots Per Inch)	12 dots/mm (305 Dots Per Inch)
Maximum Print Width	56 mm (2.2")	56 mm (2.2")	56 mm (2.2")	56 mm (2.2")
Maximum Print Length	600 mm (23.6")	400 mm (15.75")	600 mm (23.6")	400 mm (15.75")

Section 6: General Specifications

MODEL NAME	CG208 DT/ CG208TT	CG212 DT/ CG212TT
-------------------	-------------------	-------------------

MEDIA (Be sure to use media manufactured or certified by SATO)	
-----------------------------------------------------------------------	--

Type	Direct Thermal / Thermal Transfer depending on print model (DT or TT) Roll stock or Fan-fold																					
Wind Direction	Roll stock: Face In or Face out																					
Roll and Core Diameter	Maximum outer diameter: 130 mm (5.12") with Inner core diameter: 40 mm (1.5") Maximum outer diameter: 115 mm (4.5") with Inner core diameter: 26.9 mm (1") * Use the paper roll and roll core based on the above sizes to fit inside the printer. * Use an optional external label unwinder for the paper roll which outer diameter is 130mm and above.																					
Fanfold Max. stack height	100 mm (3.94") (external supply)																					
Size	<table border="1" style="width: 100%; border-collapse: collapse;"> <tr> <td style="background-color: #d9e1f2;">Label</td> <td></td> </tr> <tr> <td>Continuous</td> <td> Pitch: 6 to 600 mm (0.23" to 23.62") Pitch including liner: 9 to 603 mm (0.35" to 23.74") Width: 12 to 60 mm (0.47" to 2.36") Width including liner: 15 to 63 mm (0.59" to 2.48") </td> </tr> <tr> <td>Cutter</td> <td> Pitch: 22 to 600 mm (0.87" to 23.62") Pitch including liner: 25 to 603 mm (0.98" to 23.74") Width: 12 to 60 mm (0.47" to 2.36") Width including liner: 15 to 63 mm (0.59" to 2.48") </td> </tr> <tr> <td>Tear-off</td> <td> Pitch: 12 to 600 mm (0.47" to 23.62") Pitch including liner: 15 to 603 mm (0.59" to 23.74") Width: 12 to 60 mm (0.47" to 2.36") Width including liner: 15 to 63 mm (0.59" to 2.48") </td> </tr> <tr> <td>Dispenser</td> <td> Pitch: 22 to 100 mm (0.87" to 3.94") Pitch including liner: 25 to 103 mm (0.98" to 4.06") Width: 12 to 60 mm (0.47" to 2.36") Width including liner: 15 to 63 mm (0.59" to 2.48") </td> </tr> </table>	Label		Continuous	Pitch: 6 to 600 mm (0.23" to 23.62") Pitch including liner: 9 to 603 mm (0.35" to 23.74") Width: 12 to 60 mm (0.47" to 2.36") Width including liner: 15 to 63 mm (0.59" to 2.48")	Cutter	Pitch: 22 to 600 mm (0.87" to 23.62") Pitch including liner: 25 to 603 mm (0.98" to 23.74") Width: 12 to 60 mm (0.47" to 2.36") Width including liner: 15 to 63 mm (0.59" to 2.48")	Tear-off	Pitch: 12 to 600 mm (0.47" to 23.62") Pitch including liner: 15 to 603 mm (0.59" to 23.74") Width: 12 to 60 mm (0.47" to 2.36") Width including liner: 15 to 63 mm (0.59" to 2.48")	Dispenser	Pitch: 22 to 100 mm (0.87" to 3.94") Pitch including liner: 25 to 103 mm (0.98" to 4.06") Width: 12 to 60 mm (0.47" to 2.36") Width including liner: 15 to 63 mm (0.59" to 2.48")	<table border="1" style="width: 100%; border-collapse: collapse;"> <tr> <td style="background-color: #d9e1f2;">Label</td> <td></td> </tr> <tr> <td>Continuous</td> <td> Pitch: 6 to 400 mm (0.23" to 15.75") Pitch including liner: 9 to 403 mm (0.35" to 15.87") Width: 12 to 60 mm (0.47" to 2.36") Width including liner: 15 to 63 mm (0.59" to 2.48") </td> </tr> <tr> <td>Cutter</td> <td> Pitch: 22 to 400 mm (0.87" to 15.75") Pitch including liner: 25 to 403 mm (0.98" to 15.87") Width: 12 to 60 mm (0.47" to 2.36") Width including liner: 15 to 63 mm (0.59" to 2.48") </td> </tr> <tr> <td>Tear-off</td> <td> Pitch: 12 to 400 mm (0.47" to 15.75") Pitch including liner: 15 to 403 mm (0.59" to 15.87") Width: 12 to 60 mm (0.47" to 2.36") Width including liner: 15 to 63 mm (0.59" to 2.48") </td> </tr> <tr> <td>Dispenser</td> <td> Pitch: 22 to 100 mm (0.87" to 3.94") Pitch including liner: 25 to 103 mm (0.98" to 4.06") Width: 12 to 60 mm (0.47" to 2.36") Width including liner: 15 to 63 mm (0.59" to 2.48") </td> </tr> </table>	Label		Continuous	Pitch: 6 to 400 mm (0.23" to 15.75") Pitch including liner: 9 to 403 mm (0.35" to 15.87") Width: 12 to 60 mm (0.47" to 2.36") Width including liner: 15 to 63 mm (0.59" to 2.48")	Cutter	Pitch: 22 to 400 mm (0.87" to 15.75") Pitch including liner: 25 to 403 mm (0.98" to 15.87") Width: 12 to 60 mm (0.47" to 2.36") Width including liner: 15 to 63 mm (0.59" to 2.48")	Tear-off	Pitch: 12 to 400 mm (0.47" to 15.75") Pitch including liner: 15 to 403 mm (0.59" to 15.87") Width: 12 to 60 mm (0.47" to 2.36") Width including liner: 15 to 63 mm (0.59" to 2.48")	Dispenser	Pitch: 22 to 100 mm (0.87" to 3.94") Pitch including liner: 25 to 103 mm (0.98" to 4.06") Width: 12 to 60 mm (0.47" to 2.36") Width including liner: 15 to 63 mm (0.59" to 2.48")
Label																						
Continuous	Pitch: 6 to 600 mm (0.23" to 23.62") Pitch including liner: 9 to 603 mm (0.35" to 23.74") Width: 12 to 60 mm (0.47" to 2.36") Width including liner: 15 to 63 mm (0.59" to 2.48")																					
Cutter	Pitch: 22 to 600 mm (0.87" to 23.62") Pitch including liner: 25 to 603 mm (0.98" to 23.74") Width: 12 to 60 mm (0.47" to 2.36") Width including liner: 15 to 63 mm (0.59" to 2.48")																					
Tear-off	Pitch: 12 to 600 mm (0.47" to 23.62") Pitch including liner: 15 to 603 mm (0.59" to 23.74") Width: 12 to 60 mm (0.47" to 2.36") Width including liner: 15 to 63 mm (0.59" to 2.48")																					
Dispenser	Pitch: 22 to 100 mm (0.87" to 3.94") Pitch including liner: 25 to 103 mm (0.98" to 4.06") Width: 12 to 60 mm (0.47" to 2.36") Width including liner: 15 to 63 mm (0.59" to 2.48")																					
Label																						
Continuous	Pitch: 6 to 400 mm (0.23" to 15.75") Pitch including liner: 9 to 403 mm (0.35" to 15.87") Width: 12 to 60 mm (0.47" to 2.36") Width including liner: 15 to 63 mm (0.59" to 2.48")																					
Cutter	Pitch: 22 to 400 mm (0.87" to 15.75") Pitch including liner: 25 to 403 mm (0.98" to 15.87") Width: 12 to 60 mm (0.47" to 2.36") Width including liner: 15 to 63 mm (0.59" to 2.48")																					
Tear-off	Pitch: 12 to 400 mm (0.47" to 15.75") Pitch including liner: 15 to 403 mm (0.59" to 15.87") Width: 12 to 60 mm (0.47" to 2.36") Width including liner: 15 to 63 mm (0.59" to 2.48")																					
Dispenser	Pitch: 22 to 100 mm (0.87" to 3.94") Pitch including liner: 25 to 103 mm (0.98" to 4.06") Width: 12 to 60 mm (0.47" to 2.36") Width including liner: 15 to 63 mm (0.59" to 2.48")																					

MODEL NAME	CG208 DT	CG212 DT	CG208 TT	CG212 TT
------------	----------	----------	----------	----------

MEDIA (Be sure to use media manufactured or certified by SATO)									
Size	<table border="1"> <thead> <tr> <th>Non-adhesive paper/ Tag</th> <th>Non-adhesive paper/ Tag</th> </tr> </thead> <tbody> <tr> <td> Continuous Pitch: 9 to 603 mm (0.35" to 23.74") Width: 15 to 63 mm (0.59" to 2.48") </td> <td> Continuous Pitch: 9 to 403 mm (0.35" to 15.87") Width: 15 to 63 mm (0.59" to 2.48") </td> </tr> <tr> <td> Cutter Pitch: 25 to 603 mm (0.98" to 23.74") Width: 15 to 63 mm (0.59" to 2.48") </td> <td> Cutter Pitch: 25 to 403 mm (0.98" to 15.87") Width: 15 to 63 mm (0.59" to 2.48") </td> </tr> <tr> <td> Tear-off Pitch: 15 to 603 mm (0.59" to 23.74") Width: 15 to 63 mm (0.59" to 2.48") </td> <td> Tear-off Pitch: 15 to 403 mm (0.59" to 15.87") Width: 15 to 63 mm (0.59" to 2.48") </td> </tr> </tbody> </table>	Non-adhesive paper/ Tag	Non-adhesive paper/ Tag	Continuous Pitch: 9 to 603 mm (0.35" to 23.74") Width: 15 to 63 mm (0.59" to 2.48")	Continuous Pitch: 9 to 403 mm (0.35" to 15.87") Width: 15 to 63 mm (0.59" to 2.48")	Cutter Pitch: 25 to 603 mm (0.98" to 23.74") Width: 15 to 63 mm (0.59" to 2.48")	Cutter Pitch: 25 to 403 mm (0.98" to 15.87") Width: 15 to 63 mm (0.59" to 2.48")	Tear-off Pitch: 15 to 603 mm (0.59" to 23.74") Width: 15 to 63 mm (0.59" to 2.48")	Tear-off Pitch: 15 to 403 mm (0.59" to 15.87") Width: 15 to 63 mm (0.59" to 2.48")
	Non-adhesive paper/ Tag	Non-adhesive paper/ Tag							
Continuous Pitch: 9 to 603 mm (0.35" to 23.74") Width: 15 to 63 mm (0.59" to 2.48")	Continuous Pitch: 9 to 403 mm (0.35" to 15.87") Width: 15 to 63 mm (0.59" to 2.48")								
Cutter Pitch: 25 to 603 mm (0.98" to 23.74") Width: 15 to 63 mm (0.59" to 2.48")	Cutter Pitch: 25 to 403 mm (0.98" to 15.87") Width: 15 to 63 mm (0.59" to 2.48")								
Tear-off Pitch: 15 to 603 mm (0.59" to 23.74") Width: 15 to 63 mm (0.59" to 2.48")	Tear-off Pitch: 15 to 403 mm (0.59" to 15.87") Width: 15 to 63 mm (0.59" to 2.48")								
Thickness	0.06 to 0.19 mm (0.0024" to 0.0075") * The specification for wrist-band has to be confirm individually.								

RIBBON (Be sure to use ribbon manufactured or certified by SATO)	
Wind Direction	Face Out
Winding Method	Paper core
Roll Diameter	Maximum outer diameter: 38 mm (1.5")
Core Diameter	Inner core diameter: 12.7 mm(0.5")
Width	Max. 59mm (2.32")

PROCESSING	
CPU	32 Bit RISC-CPU 133MHz
Flash ROM	4 Megabytes
RAM	8 Megabytes

PRINTER LANGUAGE	
Standard	SATO Barcode Printer Language (SBPL)

INTERFACES	
Standard Configurations	Select one of the following. (The factory will provide the unit with the selected interface.) 1) USB 2.0(Type B) with RS-232C(D-sub 9-pin type) or 2) USB 2.0(Type B) with LAN(10BASE-T/100BASE-TX Automatic Switching) *The RS-232C connector can be used to connect the printer to a computer or the Keypad.
User installable Optional Interface Board	Wireless LAN (802.11b/g Auto-switching) interface kit (External) *Applicable to USB with RS232C model only

Section 6: General Specifications

MODEL NAME	CG208 DT	CG212 DT	CG208 TT	CG212 TT
------------	----------	----------	----------	----------

SENSING

Gap/Tag-hole (Transmissive)	Sensitivity Adjustable
I-Mark (Reflective)	Sensitivity Adjustable
Cover Open	Fixed
Ribbon End	Fixed
Dispenser	Only available if installed

LABEL ISSUING MODES

	Standard: Continuous mode, Tear -off mode, Sensor off mode
	Optional mode: Dispenser mode, Cutter mode

SELF-DIAGNOSIS

	Print Head Check Cover Open Detection Paper End Detection Test Print	Print Head Check Cover Open Detection Paper Detection Test Print Ribbon end Detection Ribbon near end Detection
--	-------------------------------------------------------------------------------	--------------------------------------------------------------------------------------------------------------------------------

CHARACTER FONT CAPABILITIES

BITMAP FONTS

XU	5 dots W x 9 dots H (Alphanumeric characters and symbols)			
XS	17 dots W x 17 dots H (Alphanumeric characters and symbols)			
XM	24 dots W x 24 dots H (Alphanumeric characters and symbols)			
XB	48 dots W x 48 dots H (Alphanumeric characters and symbols)			
XL	48 dots W x 48 dots H (Alphanumeric characters and symbols)			
OA Font (OCR-A)	15 dots x 22 dots (Alphanumeric characters and symbols)	22 dots x 33 dots (Alphanumeric characters and symbols)	15 dots x 22 dots (Alphanumeric characters and symbols)	22 dots x 33 dots (Alphanumeric characters and symbols)
OB Font (OCR-B)	20 dots x 24 dots (Alphanumeric characters and symbols)	30 dots x 36 dots (Alphanumeric characters and symbols)	20 dots x 24 dots (Alphanumeric characters and symbols)	30 dots x 36 dots (Alphanumeric characters and symbols)

KANJI FONTS

	Supported by downloading one of the following kanji fonts. 1) Japanese (16 x 16, 22 x 22, 24 x 24/ Kaku Gothic (JIS X 208)) 2) Chinese (24 x24 GB2312) 3) Korean (24 x 24 KSX1001)
--	---------------------------------------------------------------------------------------------------------------------------------------------------------------------------------------------

RASTER FONTS

	CG Times (Alphanumeric characters and symbols)
	CG Triumvirate (Alphanumeric characters and symbols)

OUTLINE FONTS

	Alphanumeric characters and symbols
--	-------------------------------------

MODEL NAME	CG208 DT	CG212 DT	CG208 TT	CG212 TT
------------	----------	----------	----------	----------

CHARACTER FONT CAPABILITIES	
CHARACTER CONTROL	
Magnification	Expansion up to 12 x in either the vertical or horizontal
BARCODE CAPABILITIES	
Linear Bar Codes	UPC-A/UPC-E, JAN/EAN, CODE39, CODE93, CODE128, GS1-128 (UCC/EAN128), CODABAR(NW-7), ITF, Industrial 2 of 5, Matrix 2 of 5, BOOKLAND, MSI, POSTNET, GS1 DataBar (RSS) * GS1 DataBar is new version of RSS-14.
Two Dimensional codes	QR code, Micro QR, PDF417, Micro PDF, MAXI code, GS1 DataMatrix (ECC200)
Composite Symbols	EAN-13 Composite (CC-A/CC-B) EAN-8 Composite (CC-A/CC-B) UPC-A Composite (CC-A/CC-B) UPC-E Composite (CC-A/CC-B) GS1 DataBar Composite (CC-A/CC-B) GS1 DataBar Truncated Composite (CC-A/CC-B) GS1 DataBar Stacked Composite (CC-A/CC-B) GS1 DataBar Stacked Omni-Directional Composite (CC-A/CC-B) GS1 DataBar Limited Composite (CC-A/CC-B) GS1 DataBar Expanded Composite (CC-A/CC-B) GS1 DataBar Expanded Stacked Composite (CC-A/CC-B) GS1-128 Composite (CC-A/CC-B/CC-C) * GS1 DataBar is new version of RSS-14.
Ratios	1:2, 1:3, 2:5, User definable bar widths
Magnification	1 x to 12 x
Rotation	Parallel 1 (0°), Paralle1 2 (180°), Serial 1 (90°) and Serial 2 (270°)

STANDARD FUNCTIONS	
	<ol style="list-style-type: none"> 1) Status return function 2) Graphic function 3) Sequential number function 4) Form overlay function 5) Custom character registration function 6) Black/white inversion function 7) Ruled line function 8) Format registration function 9) Zero slash switching function 10) JIS/Shift JIS switching function

Section 6: General Specifications

MODEL NAME	CG208 DT	CG212 DT	CG208 TT	CG212 TT
------------	----------	----------	----------	----------

HARDWARE AND RELATED	
Operation keys	POWER and FEED/LINE buttons
Indicators	ON LINE (POWER): One (lights or flashes in two colors: green or red).
Potentiometer for adjustment	VR1 - Label Gap sensor adjustment/ Center tag hole sensor adjustment (Adjusts the sensor slice level.) VR2 - I-mark sensor adjustment (Adjusts the sensor slice level.) VR3 - Cut position adjustment (Only applicable when cutter unit is installed.) Label dispenser stop position adjustment (Only applicable when dispenser unit is installed.)
Surface Treatment	Antibacterial finishing for external cover and operative parts. Tested according to JIS Z 2801 standard

OPTIONS	
	1) Cutter Unit 2) Dispenser Unit 3) RFID kit (13.56 MHz) 4) External Unwinder Unit 5) Keypad *Applicable to USB with RS232C model only. Connect to RS232C terminal. 6) Wireless LAN (802.11b/g Auto switch) interface kit (External) *Applicable to USB with RS232C model only. Connect to USB terminal.

REGULATORY COMPLIANCE	
Safety regulation	CCC (GB4943-2001)
EMC regulation	FCC15B Class B (USA/Canada) CE (EN55022, EN55024) (Europe) CISPR22, CISPR24 (reference standard, Singapore) GB9254-1998, GB17625.1(2003) (China) KN22, KN24 (Korea)
Wireless regulation	Wireless LAN (2.45 GHz) FCC15B/ FCC15C (USA/Canada) R&TTE (EN300 328 V1.4:2003-04), (EN301 489 V1.4.1:2002-08) (Europe) IDA TS SRD:2004 (Singapore) SRRC (China) MIC (Korea)
	RFID (HF) FCC15B/ FCC15C (USA/Canada) R&TTE (EN300-330) (Europe) IDA TS 10 (Singapore) MIC (Korea)
Packing Drop Standard	ISTA-2A
Environmental (RoHS)	Chromium: below 0.1% Lead: below 0.1% Mercury: below 0.1% Cadmium: below 0.01% Polybrominated Biphenyl (PBB): below 0.1% Polybrominated Diphenyl Ether (PBDE): below 0.1%

6.2 OPTIONAL ACCESSORIES SPECIFICATIONS

CUTTER SPECIFICATIONS	
Media Type	Non-adhesive paper and Label
Media Size	Pitch including liner: 25 to 603 mm (0.98" to 23.74") (For CG208TT/ CG208DT) Pitch including liner: 25 to 403 mm (0.98" to 15.87") (For CG212TT/ CG212DT) Width including liner: 15 to 63 mm (0.59" to 2.48")
Thickness	0.06 to 0.16 mm (0.002 to 0.006 in.)
Dimensions	W 108 X D 50 X H 98 mm (W 4.25" X D 1.97" X H 3.86")
Weight	0.3 kg (0.66 lbs)

DISPENSER SPECIFICATIONS	
Media Type	Label only * Some restrictions may apply to some label types depending on the substrate, adhesive, paper size, and environment. Refer to SATO representative on the labels to be used. * Split liner cannot be used for this model. * Perforated liner cannot be used for this model.
Media Size	Width: 12 to 60 mm (0.47" to 2.36") Width including liner: 15 to 63 mm (0.59" to 2.48") Pitch: 22 to 100 mm (0.87" to 3.94") Pitch including liner: 25 to 103 mm (0.98" to 4.06")
Thickness	0.06 to 0.19 mm (0.0024" to 0.0075")
Sensor Type	Dispenser sensor (Reflective)
Dimensions	W 108 X D 35 X H 95 mm (W 4.25" X D 1.38" X H 3.74")
Weight	0.12 kg (0.26 lbs)

This page is intentionally left blank

7

INTERFACE SPECIFICATIONS

This section presents the interface types and their specifications for the CG2 series printers. These specifications include detailed information to assist in the selection of the most appropriate method for the printer to interface with the host.

The following information is presented in this section:

- 7.1 Interface types
- 7.2 RS232C Serial Interface
- 7.3 Universal Serial Bus (USB) Interface
- 7.4 Local Area Network (LAN) Ethernet and Wireless LAN

7.1 INTERFACE TYPES

CG2 series have 2 types of Main PCB and each type of PCB is equipped with different type of interface to perform data communication with the host. These are described as follows.

- 1) **Type 1:** USB and RS232C on-board
- 2) **Type 2:** USB and LAN on-board

Note: Wireless LAN interface is also available as an option and can only be installed to printer with Type 1 board.

Model	Interface Types			
	USB	RS232C	LAN	Wireless LAN (Option)
CG2 series (Type 1)	Yes* ¹	Yes* ¹	-	Yes* ²
CG2 series (Type 2)	Yes* ¹	-	Yes* ¹	-

*¹: On-board interface

*²: Uses USB port for installation



Caution

Never connect or disconnect interface cables (or use a switch box) with power applied to either the host or printer. This may caused damage to the interface circuitry in the printer/ host and is not covered by warranty.

7.2 RS232C SERIAL INTERFACE

7.2.1 Basic Specifications of RS-232C Serial Interface



This interface complies with the RS-232C standard. It is available with Type 1 board.

Interface connector	 <p>DB-9S or equivalent (Male) Cable length: 5m or less</p>																																																
Communication settings	<p>Use Printer configuration tool or <I2> command to setup. <I2>abcde</p> <table border="1" data-bbox="528 887 1369 1899"> <thead> <tr> <th>Parameter</th> <th>Item</th> <th>Value</th> <th>Description</th> </tr> </thead> <tbody> <tr> <td rowspan="5">a</td> <td rowspan="5">Baud rate</td> <td>4</td> <td>115200bps</td> </tr> <tr> <td>3</td> <td>57600bps</td> </tr> <tr> <td>2</td> <td>38400bps</td> </tr> <tr> <td>1</td> <td>19200bps [Default]</td> </tr> <tr> <td>0</td> <td>9600bps</td> </tr> <tr> <td rowspan="2">b</td> <td rowspan="2">Data bit length</td> <td>1</td> <td>7 bits</td> </tr> <tr> <td>0</td> <td>8 bits [Default]</td> </tr> <tr> <td rowspan="3">c</td> <td rowspan="3">Parity bits</td> <td>2</td> <td>EVEN</td> </tr> <tr> <td>1</td> <td>ODD</td> </tr> <tr> <td>0</td> <td>NONE [Default]</td> </tr> <tr> <td rowspan="2">d</td> <td rowspan="2">Stop bits</td> <td>1</td> <td>2 bits</td> </tr> <tr> <td>0</td> <td>1 bit [Default]</td> </tr> <tr> <td rowspan="5">e</td> <td rowspan="5">Protocol</td> <td>4</td> <td>STATUS 3</td> </tr> <tr> <td>3</td> <td>Protocol for driver (STATUS 4) [Default]</td> </tr> <tr> <td>2</td> <td>XON/XOFF</td> </tr> <tr> <td>1</td> <td>READY/BUSY (Multi reception)</td> </tr> <tr> <td>0</td> <td>READY/BUSY (Single item reception)</td> </tr> </tbody> </table>	Parameter	Item	Value	Description	a	Baud rate	4	115200bps	3	57600bps	2	38400bps	1	19200bps [Default]	0	9600bps	b	Data bit length	1	7 bits	0	8 bits [Default]	c	Parity bits	2	EVEN	1	ODD	0	NONE [Default]	d	Stop bits	1	2 bits	0	1 bit [Default]	e	Protocol	4	STATUS 3	3	Protocol for driver (STATUS 4) [Default]	2	XON/XOFF	1	READY/BUSY (Multi reception)	0	READY/BUSY (Single item reception)
Parameter	Item	Value	Description																																														
a	Baud rate	4	115200bps																																														
		3	57600bps																																														
		2	38400bps																																														
		1	19200bps [Default]																																														
		0	9600bps																																														
b	Data bit length	1	7 bits																																														
		0	8 bits [Default]																																														
c	Parity bits	2	EVEN																																														
		1	ODD																																														
		0	NONE [Default]																																														
d	Stop bits	1	2 bits																																														
		0	1 bit [Default]																																														
e	Protocol	4	STATUS 3																																														
		3	Protocol for driver (STATUS 4) [Default]																																														
		2	XON/XOFF																																														
		1	READY/BUSY (Multi reception)																																														
		0	READY/BUSY (Single item reception)																																														

7.2 RS232C SERIAL INTERFACE (cont'd)

Function descriptions

Function	Description
Baud rate setting	Select the data rate (bps) for the RS232 port.
Data bit length	Sets the printer to receive either 7 or 8 bits of data for each byte transmitted.
Parity setting	Selects the type of parity used for error detection.
Stop bit setting	Selects the number of stop bits to end each byte transmission.
Protocol setting	Selects the flow control and status reporting protocols

Synchro system	Asynchronous method												
Maximum receive buffer capacity	<p>1MB</p> <p style="text-align: center;">0MB 1MB</p> <p>Near full occurred  Remaining 0.25MB</p> <p>Near full released  Remaining 0.5MB</p>												
Code	ASCII (7 bits), Graphic (8 bits)												
Transmission form	<table border="1" style="margin-left: auto; margin-right: auto;"> <tr> <td>Start</td> <td>b1</td> <td>b2</td> <td>b3</td> <td>b4</td> <td>b5</td> <td>b6</td> <td>b7</td> <td>b8</td> <td>Stop</td> </tr> </table> <p>[Note] If using 7 bits, b8 will be omitted.</p>	Start	b1	b2	b3	b4	b5	b6	b7	b8	Stop		
Start	b1	b2	b3	b4	b5	b6	b7	b8	Stop				
Signal level	High level : +5 to +12V Low level : -5 to -12V												
Interface type	Use Printer configuration tool or <DI> command. <DI>a <table border="1" style="margin-left: auto; margin-right: auto;"> <thead> <tr> <th>Parameter</th> <th>Item</th> <th>Value</th> <th>Description</th> </tr> </thead> <tbody> <tr> <td rowspan="3">a</td> <td rowspan="3">Interface</td> <td>0</td> <td>USB/W-LAN [Default]</td> </tr> <tr> <td>1</td> <td>RS-232C</td> </tr> <tr> <td>2</td> <td>Keypad</td> </tr> </tbody> </table>	Parameter	Item	Value	Description	a	Interface	0	USB/W-LAN [Default]	1	RS-232C	2	Keypad
Parameter	Item	Value	Description										
a	Interface	0	USB/W-LAN [Default]										
		1	RS-232C										
		2	Keypad										

7.2 RS232C HIGH SPEED SERIAL INTERFACE (cont'd)

7.2.2 Ready/Busy

This protocol controls the reception of print data only by the control of hardware signal. Use the command <I2> to toggle between single item buffer and multi item buffer.

When the print data (STX ESC+"A"~ ESC+"Z" ETX) is sent from the host in the conditions below, received data may be incorrect.

- 1) When the printer is Offline
- 2) When an error has occurred in the printer

Pin Assignments

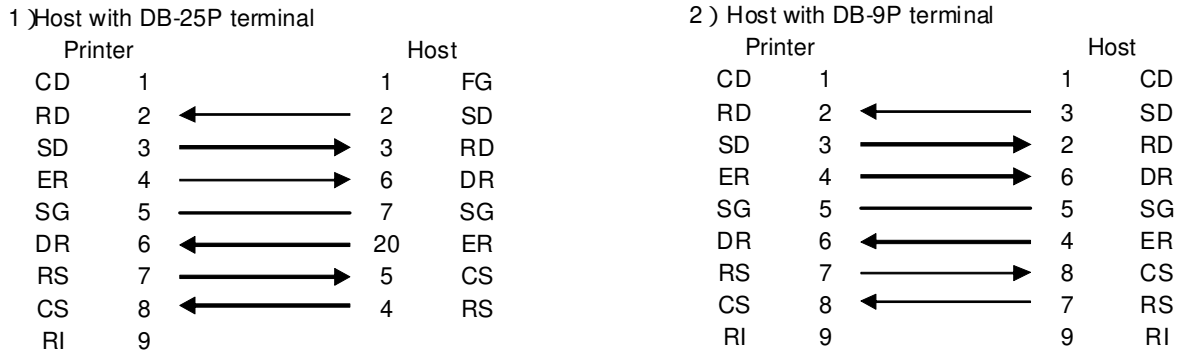

Interface Signals

Pin no.	Signal Type	Direction	Description
2	RD	Input	Data transferred from the host to the printer
3	SD	Output	Data transferred from the printer to the host
4	ER	Output	Data terminal READY
5	SG	-	Signal ground
6	DR	Input	Data set READY
7	RS	Output	Transmission request
8	CS	Input	Transmission READY
9	RI	Input	Call

Notes:

Follow the procedures below when executing READY/BUSY control.

- 1) When the host sends the data for printing labels, make sure that the printer is on.
- 2) Turning the printer on after requesting to print labels by the host may cause the lack of first print data (approx. 120 bytes).

To avoid this problem, it is necessary to attach approximate 120 bytes of dummy data by application software that enables the host to send the data for printing labels.

e.g.) When sending [STX+<A>+<V>20+<H>20+<P>2+<L>0202+<X20>,1234+<Q>2+<Z>+ETX],

transfer appropriate 120 bytes of dummy data shown below.

[00H+00H+ ~ +00H+00H+00H+00H] + [STX ~ ETX]

7.2 RS232C HIGH SPEED SERIAL INTERFACE (cont'd)

7.2.3 X-ON/X-OFF

This transmission protocol informs the host if the printer is ready to receive data, by sending the "XON" (Hex 11H) or "XOFF" (Hex 13H) code.

When the print data (STX ESC+"A"~ ESC+"Z" ETX) is sent from the host in the conditions below, received data may be incorrect.

- 1) When the printer is Offline
- 2) When an error has occurred in the printer

Pin Assignments

1) Host with DB-25P terminal

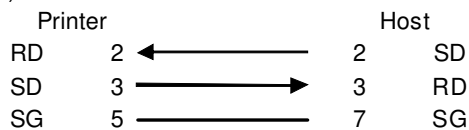

2) Host with DB-9P terminal

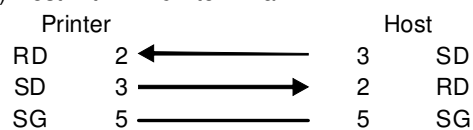

Note:

Depending on the host used, it may need to loop CS and RS (maintaining at "High" level) on the host side. Therefore, make sure to re-check the host before use.

Input/Output Signals

Pin no.	Signal Type	Direction	Description
2	RD	Input	Data transferred from the host to the printer
3	SD	Output	Data transferred from the printer to the host
5	SG	-	Signal ground

7.2.4 Return Status (STATUS 3 and Protocol for Driver (STATUS 4))

The purpose of these protocols are to control printer status on the host side. With the request command from the host, the status is returned from the printer.

After receiving the request command, the status is returned immediately.

In these communication protocols, receive mode is set to multi item buffer.

When the print data (STX ESC+"A"~ ESC+"Z" ETX) is sent from the host in the conditions below, received data may be incorrect.



- 1) When the printer is Offline
- 2) When an error has occurred in the printer

7.3 UNIVERSAL SERIAL BUS (USB) INTERFACE

This printer supports USB 2.0-compliant interface and the transfer rate at 12.5 Mbits/second. The Universal Serial Bus (USB) interface requires a driver (shipped with each printer) that must be loaded on your PC and the PC must be configured to support USB peripherals using Windows2000/XP/Server2003/Vista. Details for loading the USB driver are contained in the CD-ROM that is shipped with each printer. Up to 127 devices may be connected to a USB port using powered hubs.

7.3.1 Basic Specifications of USB interface

USB interface is available with both Type 1 and Type 2 board.

Interface connector	 <p>Series B plug Cable length: 5m or less (Twisted Pair Shielded)</p>																								
Version	USB 2.0																								
Maximum receive buffer capacity	<p>1MB</p> <p style="text-align: center;">0MB 1MB</p> <p>Near full occurred  Remaining 0.25MB</p> <p>Near full released  Remaining 0.5MB</p>																								
Interface type	<p>Use Printer configuration tool or <DI> command. <DI>a</p> <p>For Type 1 board,</p> <table border="1" data-bbox="528 1440 1369 1653"> <thead> <tr> <th>Parameter</th> <th>Item</th> <th>Value</th> <th>Description</th> </tr> </thead> <tbody> <tr> <td rowspan="3">a</td> <td rowspan="3">Interface</td> <td>0</td> <td>USB/W-LAN [Default]</td> </tr> <tr> <td>1</td> <td>RS-232C</td> </tr> <tr> <td>2</td> <td>Keypad</td> </tr> </tbody> </table> <p>For Type 2 board,</p> <table border="1" data-bbox="528 1704 1369 1917"> <thead> <tr> <th>Parameter</th> <th>Item</th> <th>Value</th> <th>Description</th> </tr> </thead> <tbody> <tr> <td rowspan="3">a</td> <td rowspan="3">Interface</td> <td>0</td> <td>USB [Default]</td> </tr> <tr> <td>1</td> <td>LAN</td> </tr> <tr> <td>2</td> <td>Keypad</td> </tr> </tbody> </table>	Parameter	Item	Value	Description	a	Interface	0	USB/W-LAN [Default]	1	RS-232C	2	Keypad	Parameter	Item	Value	Description	a	Interface	0	USB [Default]	1	LAN	2	Keypad
Parameter	Item	Value	Description																						
a	Interface	0	USB/W-LAN [Default]																						
		1	RS-232C																						
		2	Keypad																						
Parameter	Item	Value	Description																						
a	Interface	0	USB [Default]																						
		1	LAN																						
		2	Keypad																						

7.3 UNIVERSAL SERIAL BUS (USB) INTERFACE (cont'd)

7.3.2 Pin Assignments

Pin No.	Description
1	VBus
2	-Data(D-)
3	+Data(D+)
4	GND

Notes

- USB interface is supported only by Windows2000/XP/Server2003/Vista/Server2008. USB connection might be failed on some "Windows2000/XP/Server2003/Vista/Server2008" hosts. Make sure to confirm the instruction manual of your PC or consult with PC (host) manufacturer.
- Recommended length for USB cable is 1m.
- Connect USB type B plug (square form factor) to the printer.
- Device name of USB port should be "Serial number".
e.g.) CRGY0032



7.4 LOCAL AREA NETWORK (LAN) ETHERNET AND WIRELESS LAN

7.4.1 Basic Specifications of LAN

A Local Area Network (LAN) interface requires a driver shipped with each printer that has the interface installed. The driver that must be loaded on the host computer and configured to run one of the supported network protocols using a 10/100BaseT LAN connection. Details for loading the LAN driver are contained in the LAN Interface Manual that is shipped with each printer with a LAN Optional interface installed.

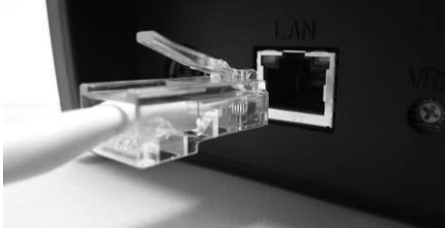
LAN interface is available with Type 2 board.

Interface connector	 <p>Cable type: For 10BASE-T and 100BASE-TX Cable length: 100m or less</p>												
Link/Status LED	<p>Status LED lights up when establishing the LINK with Ethernet equipment. The LINK is established by Auto Negotiation.</p> <table border="1" data-bbox="518 1008 1380 1254"> <thead> <tr> <th>LED</th> <th>Color</th> <th>Conditions</th> </tr> </thead> <tbody> <tr> <td>LINK</td> <td>Green</td> <td>Lights up when establishing the LINK</td> </tr> <tr> <td>SPEED</td> <td>Yellow</td> <td>Lights off when recognizing the destination 10BASE-T Lights up when recognizing the destination 100BASE-TX</td> </tr> </tbody> </table>	LED	Color	Conditions	LINK	Green	Lights up when establishing the LINK	SPEED	Yellow	Lights off when recognizing the destination 10BASE-T Lights up when recognizing the destination 100BASE-TX			
LED	Color	Conditions											
LINK	Green	Lights up when establishing the LINK											
SPEED	Yellow	Lights off when recognizing the destination 10BASE-T Lights up when recognizing the destination 100BASE-TX											
Maintenance function	<p>[Printing LAN configuration information] LAN configuration information will be printed on the third sheet of user test print and factory test print.</p> <p>[Initializing LAN configuration information] LAN configuration information will be initialized through [All Clear] of Factory Clear Mode. For more details, refer to the authorized Sato servicing personnel.</p>												
Interface type	<p>Use Printer configuration tool or <DI> command. <DI>a</p> <table border="1" data-bbox="518 1601 1380 1825"> <thead> <tr> <th>Parameter</th> <th>Item</th> <th>Value</th> <th>Description</th> </tr> </thead> <tbody> <tr> <td rowspan="3">a</td> <td rowspan="3">Interface</td> <td>0</td> <td>USB [Default]</td> </tr> <tr> <td>1</td> <td>LAN</td> </tr> <tr> <td>2</td> <td>Keypad</td> </tr> </tbody> </table>	Parameter	Item	Value	Description	a	Interface	0	USB [Default]	1	LAN	2	Keypad
Parameter	Item	Value	Description										
a	Interface	0	USB [Default]										
		1	LAN										
		2	Keypad										

<p>Communication configuration</p>	<p>The following settings can be configured via Printer configuration tool or commands.</p> <table border="1" data-bbox="518 291 1380 855"> <thead> <tr> <th>Item</th> <th>Command</th> <th>Setting range</th> </tr> </thead> <tbody> <tr> <td>LAN mode</td> <td><I3></td> <td>Protocol for driver (STATUS4) cyclic response mode *1 Protocol for driver (STATUS4) ENQ response mode *1 STATUS3 *2</td> </tr> <tr> <td>IP address</td> <td><W1></td> <td>0.0.0.0 ~ 255.255.255.255</td> </tr> <tr> <td>Subnet mask</td> <td><W2></td> <td>0.0.0.0 ~ 255.255.255.255</td> </tr> <tr> <td>Gateway address</td> <td><W3></td> <td>0.0.0.0 ~ 255.255.255.255</td> </tr> <tr> <td>IP address setup</td> <td><WI></td> <td>Manual DHCP</td> </tr> <tr> <td>RARP</td> <td><WM></td> <td>RARP disabled RARP enabled</td> </tr> </tbody> </table> <p>*1 2-port connection by Port1024 and Port1025 or 1 port connection by Port9100. *2 1 port connection by Port1024 or Port9100.</p>	Item	Command	Setting range	LAN mode	<I3>	Protocol for driver (STATUS4) cyclic response mode *1 Protocol for driver (STATUS4) ENQ response mode *1 STATUS3 *2	IP address	<W1>	0.0.0.0 ~ 255.255.255.255	Subnet mask	<W2>	0.0.0.0 ~ 255.255.255.255	Gateway address	<W3>	0.0.0.0 ~ 255.255.255.255	IP address setup	<WI>	Manual DHCP	RARP	<WM>	RARP disabled RARP enabled
Item	Command	Setting range																				
LAN mode	<I3>	Protocol for driver (STATUS4) cyclic response mode *1 Protocol for driver (STATUS4) ENQ response mode *1 STATUS3 *2																				
IP address	<W1>	0.0.0.0 ~ 255.255.255.255																				
Subnet mask	<W2>	0.0.0.0 ~ 255.255.255.255																				
Gateway address	<W3>	0.0.0.0 ~ 255.255.255.255																				
IP address setup	<WI>	Manual DHCP																				
RARP	<WM>	RARP disabled RARP enabled																				
<p>Maximum receive buffer capacity</p>	<p>1MB</p> <p style="text-align: center;">0MB 1MB</p> <p>Near full occurred </p> <p>Near full released </p>																					

7.4 LOCAL AREA NETWORK (LAN) ETHERNET AND WIRELESS LAN (cont'd)

7.4.2 Basic Specifications of Wireless LAN (Optional)

The optional Wireless LAN interface can be installed to Type 1 board via USB port.

Interface board																
Link/Status LED	<table border="1" data-bbox="518 884 1380 1406"> <thead> <tr> <th>LED</th> <th>Color</th> <th>Conditions</th> </tr> </thead> <tbody> <tr> <td>SIGNAL LEVEL</td> <td>Green</td> <td>[Radio field strength] - Lights up: Strong (75% ~ 100%) - Blinking: Medium (50% ~ 74%) - Off: Weak (0% ~ 49%)</td> </tr> <tr> <td>LINK</td> <td>Green</td> <td>[Link] - Blinking: Waiting for Link detection - Lights up: Linked</td> </tr> <tr> <td>ACT</td> <td>Orange</td> <td>[Status] - Blinking: Blinks for a certain period when receiving the packet</td> </tr> <tr> <td>WLAN MODE</td> <td>Green</td> <td>[Mode] - Blinking: Ad hoc mode - Lights up: Infrastructure mode</td> </tr> </tbody> </table>	LED	Color	Conditions	SIGNAL LEVEL	Green	[Radio field strength] - Lights up: Strong (75% ~ 100%) - Blinking: Medium (50% ~ 74%) - Off: Weak (0% ~ 49%)	LINK	Green	[Link] - Blinking: Waiting for Link detection - Lights up: Linked	ACT	Orange	[Status] - Blinking: Blinks for a certain period when receiving the packet	WLAN MODE	Green	[Mode] - Blinking: Ad hoc mode - Lights up: Infrastructure mode
LED	Color	Conditions														
SIGNAL LEVEL	Green	[Radio field strength] - Lights up: Strong (75% ~ 100%) - Blinking: Medium (50% ~ 74%) - Off: Weak (0% ~ 49%)														
LINK	Green	[Link] - Blinking: Waiting for Link detection - Lights up: Linked														
ACT	Orange	[Status] - Blinking: Blinks for a certain period when receiving the packet														
WLAN MODE	Green	[Mode] - Blinking: Ad hoc mode - Lights up: Infrastructure mode														
Interface type	<p>Use Printer configuration tool or <DI> command. <DI>a</p> <table border="1" data-bbox="518 1541 1380 1758"> <thead> <tr> <th>Parameter</th> <th>Item</th> <th>Value</th> <th>Decription</th> </tr> </thead> <tbody> <tr> <td rowspan="3">a</td> <td rowspan="3">Interface</td> <td>0</td> <td>USB/WLAN [Default]</td> </tr> <tr> <td>1</td> <td>RS-232C</td> </tr> <tr> <td>2</td> <td>Keypad</td> </tr> </tbody> </table>	Parameter	Item	Value	Decription	a	Interface	0	USB/WLAN [Default]	1	RS-232C	2	Keypad			
Parameter	Item	Value	Decription													
a	Interface	0	USB/WLAN [Default]													
		1	RS-232C													
		2	Keypad													

<p>Communication configuration</p>	<p>The following settings can be configured via Printer configuration tool or commands.</p> <table border="1" data-bbox="518 291 1380 593"> <thead> <tr> <th>Item</th> <th>Command</th> <th>Setting range</th> </tr> </thead> <tbody> <tr> <td>LAN mode</td> <td><I3></td> <td>Protocol for driver (STATUS4) cyclic response mode *¹ Protocol for driver (STATUS4) ENQ response mode *¹ STATUS3 *²</td> </tr> <tr> <td>Wireless LAN</td> <td><WZ></td> <td>Wireless LAN setup *³</td> </tr> </tbody> </table> <p>*¹ 2-port connection by Port1024 and Port1025 or 1 port connection by Port9100. *² 1 port connection by Port1024 or Port9100. *³ Refer to Command specifications for more information.</p>	Item	Command	Setting range	LAN mode	<I3>	Protocol for driver (STATUS4) cyclic response mode * ¹ Protocol for driver (STATUS4) ENQ response mode * ¹ STATUS3 * ²	Wireless LAN	<WZ>	Wireless LAN setup * ³
Item	Command	Setting range								
LAN mode	<I3>	Protocol for driver (STATUS4) cyclic response mode * ¹ Protocol for driver (STATUS4) ENQ response mode * ¹ STATUS3 * ²								
Wireless LAN	<WZ>	Wireless LAN setup * ³								
<p>Wi-Fi</p>	<ol style="list-style-type: none"> 1) Standard IEEE802.11b/g 2) Frequency 2.4GHz 3) Transfer rate Max. 11Mbps (IEEE802.11b) Max. 54Mbps (IEEE802.11g) 4) W-LAN communication mode Infrastructure mode Ad hoc mode 5) Channel 1 to 11 ch 6) SSID Alphanumeric up to 32 characters (except for ',' (comma) and '"' (double quotation)) 7) Authentication method None IEEE802.11 (authentication with access points) WEP (Open System / Shared Key) IEEE802.11 (authentication between W-LAN devices) WPA (PSK (Pre-Shared Key) or IEEE 802.1x authentication) WPA2 (PSK (Pre-Shared Key) or IEEE 802.1x authentication) IEEE 802.1x (EAP-LEAP, EAP-TLS, EAP-PEAP, or EAP-TTLS) (Herein after called "EAP") 8) Encryption method None WEP key TKIP AES 									

7.4 LOCAL AREA NETWORK (LAN) ETHERNET AND WIRELESS LAN (cont'd)

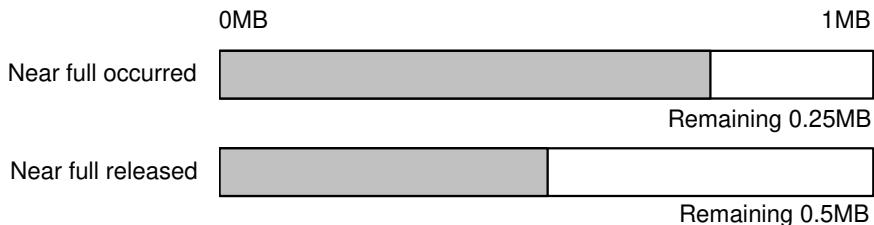
	<p>9) Security (Combination of authentication and encryption)</p> <p>Ad hoc mode</p> <table border="1" data-bbox="518 392 1380 604"> <thead> <tr> <th>Security</th> <th>IEEE 802.11</th> <th>IEEE 802.11i</th> <th>Encryption</th> </tr> </thead> <tbody> <tr> <td>None</td> <td>None</td> <td>None</td> <td>None</td> </tr> <tr> <td rowspan="2">WEP</td> <td>Open System</td> <td rowspan="2">None</td> <td rowspan="2">WEP key</td> </tr> <tr> <td>Shared Key</td> </tr> </tbody> </table> <p>Infrastructure mode</p> <table border="1" data-bbox="518 660 1380 1137"> <thead> <tr> <th>Security</th> <th>IEEE 802.11</th> <th>IEEE 802.11i</th> <th>Encryption</th> </tr> </thead> <tbody> <tr> <td>None</td> <td>None</td> <td>None</td> <td>None</td> </tr> <tr> <td rowspan="2">WEP</td> <td>Open System</td> <td>None</td> <td rowspan="2">WEP key</td> </tr> <tr> <td>Shared Key</td> <td>None</td> </tr> <tr> <td rowspan="2">WPA</td> <td rowspan="2">None</td> <td>PSK</td> <td rowspan="2">TKIP</td> </tr> <tr> <td>EAP</td> </tr> <tr> <td rowspan="2">WPA2</td> <td rowspan="2">None</td> <td>PSK</td> <td rowspan="2">AES</td> </tr> <tr> <td>EAP</td> </tr> <tr> <td>Dynamic WEP</td> <td>None</td> <td>EAP</td> <td>WEP key</td> </tr> </tbody> </table> <p>[Notes] Consult your system administrator about the interference from radio waves when using the printer near medical equipment and facilities.</p>	Security	IEEE 802.11	IEEE 802.11i	Encryption	None	None	None	None	WEP	Open System	None	WEP key	Shared Key	Security	IEEE 802.11	IEEE 802.11i	Encryption	None	None	None	None	WEP	Open System	None	WEP key	Shared Key	None	WPA	None	PSK	TKIP	EAP	WPA2	None	PSK	AES	EAP	Dynamic WEP	None	EAP	WEP key
Security	IEEE 802.11	IEEE 802.11i	Encryption																																							
None	None	None	None																																							
WEP	Open System	None	WEP key																																							
	Shared Key																																									
Security	IEEE 802.11	IEEE 802.11i	Encryption																																							
None	None	None	None																																							
WEP	Open System	None	WEP key																																							
	Shared Key	None																																								
WPA	None	PSK	TKIP																																							
		EAP																																								
WPA2	None	PSK	AES																																							
		EAP																																								
Dynamic WEP	None	EAP	WEP key																																							
<p>Maximum receive buffer capacity</p>	<p>1MB</p> 																																									

7.4.3 Software Specifications

Protocol	TCP/IP
Network layer	ARP, RARP, IP, ICMP
Session layer	TCP, UDP
Application layer	LPR, FTP, TELNET, BOOTP, DHCP, HTTP

Notes

- Send the print data by LPR and FTP of TCP/IP and dedicated socket protocol.
- Use socket connection to get the printer status.

7.4 LOCAL AREA NETWORK (LAN) ETHERNET AND WIRELESS LAN (cont'd)

7.4.4 TCP/IP Specifications

In TCP/IP protocol environment, LPD and FTP are provided for printing. TELNET for the setup of various variables, and ARP, RARP and BOOTP/DHCP for the setup of IP address are available.

In socket connection, the printing operation and the status are monitored. In this case, multiple connections cannot be established at the same time.

WindowsNT and Windows2000/XP/Server2003/Vista/Sever2008 support LPD of TCP/IP that enables you to print; however, Windows98/Me is not configured with LPD. In order to perform printing operation, off-the-shelf printing software is required.

IP address and variables can be set using the utility [Network Setting Tool] through Windows2000(excluding Advanced Server)/XP/Server2003(R2 untested)/Vista/Server2008.

7.4.5 LPD Specifications

LPD protocol complies with RFC1179 and handles the list of logical printer name as queue name such as lp, sjis and euc.

Queue name	Kanji filter applied	Input Kanji code
lp	Not available	N/A
sjis	Available	Shift JIS
euc	Available	EUC

When sending a job by LPR, the transmission order of data file/control file within the job does not affect the printing operation.

Notes

- A job deletion by LPR is not supported.
- LPD is available only for Protocol for Driver.
- If executing large quantity printing by LPD, some part of data may be missed due to the Windows specifications.
- It does not support Banner page printing.

7.4.6 FTP Specifications

FTP protocol complies with RFC959 and handles the list of logical printer name as transfer directory. File transfer to this directory executes printing operation. Note that it is possible to specify ASCII(A), BINARY(I), and TENEX(L8) as transfer mode although mode difference is dependent on the client side.

There are three directory names such as lp, sjis and euc.

Queue name	Kanji filter applied	Input Kanji code
lp	Not available	N/A
sjis	Available	Shift JIS
euc	Available	EUC

Note

It does not support Banner page printing.

7.4 LOCAL AREA NETWORK (LAN) ETHERNET AND WIRELESS LAN (cont'd)

7.4.7 TELNET Specifications

TELNET complies with RFC854. This is consisted of interactive menu form, and it enables to change and refer internal setup and to display status. To change the setting details, enter 'root' user name and password at the time of login. Default ROOT password is set to null (line feed only).

<TELNET command example>

In MS-DOS command prompt, type in [TELNET xxx.xxx.xxx.xxx (IP address)] and enter user name and password to advance to the display below.

```
SATO PRINTER ModelName TELNET server.
Copyright 2006(C) SATO Corporation.
```

```
login: root
'root' user needs password to login
password:
User 'root' logged in
```

No.	Item	Value	(level.1)
1	Setup TCP/IP		
2	Display status		
99	Exit setup		
Please select(1-99)?			

Each printer model name will be appeared in [Model Name].

For the detailed settings of [1:Setup TCP/IP], refer to [7.4.8 Setting/Displayed Items].

7.4.8 Setting/Displayed Items

The following table shows the settings and referable sections as well as various variables.

TCP/IP related settings

Variable identifier	Default (Factory setting)	Setting range
IP address	0.0.0.0 (Externally obtained)	0.0.0.0 ~ 255.255.255.255
Subnet mask	0.0.0.0 (Derived from IP address)	0.0.0.0 ~ 255.255.255.255
Gateway address	0.0.0.0 (Invalid)	0.0.0.0 ~ 255.255.255.255
RARP protocol	ENABLE	ENABLE/DISABLE
DHCP protocol	ENABLE	ENABLE/DISABLE
Keep alive time	180(sec)	30 ~ 300
Socket cancel	Normal	Normal / compatible
ROOT password	NULL (No password)	Up to 16 alphanumeric characters

7.4 LOCAL AREA NETWORK (LAN) ETHERNET AND WIRELESS LAN (cont'd)

7.4.9 Wireless LAN Setting

Item		Default	Setting range
WLAN		1	0: Infrastructure (use SSID) 1: Ad hoc
SSID		"SATO"	1 ~ 32 characters (*4)
Channel		11	1 ~ 11 (*2)
WLAN Authentication		0	0: Open System 1: Shared Key
Security Mode		0	0: Not used 1: WEP 2: WPA 3: WPA2 4: DynamicWEP
Configure WEP Key (Set this item when encrypting with WEP key)	WEP Key1	""(NULL)	40 bit WEP: (*1) 5 characters 10-digit HEX code 104 bit WEP: 13 characters 26-digit HEX code
	WEP Key2	""(NULL)	
	WEP Key3	""(NULL)	
	WEP Key4	""(NULL)	
	WEP Key Index	1	1 ~ 4
Configure WPA (Set this item when using WPA/WPA2)	WPA Authentication	0	0: PSK 1: EAP(IEEE802.1X)
	WPA PSK Mode	0	0: TKIP 1: AES
	WPA PSK	""(NULL)	8 ~ 63 characters (*4)
Configure 802.1x (Set this item when using 802.1x authentication)	EAPMode	0	0: EAP not used 1: Reserved 2: EAP-TLS 3: EAP-PEAP 4: Reserved 5: EAP-LEAP 6: EAP-TTLS
	EAP User Name	""(NULL)	1 ~ 63 characters (*4)
	EAP Password	""(NULL)	0 ~ 32 characters (*4)
	EAP Cert Key Password	""(NULL)	0 ~ 32 characters (*4)

7.4 LOCAL AREA NETWORK (LAN) ETHERNET AND WIRELESS LAN (cont'd)

Other Wireless LAN settings

Item		Default	Setting range
Network	IP Setup Method	0	0: DHCP/BOOTP disabled 1:DHCP/BOOTP enabled
	Rarp	0	0: RARP disabled 1: RARP enabled
	Local IP address	192 168 001 001	000 000 000 000 ~ 255 255 255 255
	Subnet Mask	255 255 255 000	000 000 000 000 ~ 255 255 255 255
	Gateway Address	000 000 000 000	000 000 000 000 ~ 255 255 255 255
FTP	Ftp Disc Time-out	030	30 ~ 500 (sec)
RAWTCPServer	Raw Disc Time-out	0300	0 ~ 3600 (sec)
LDP	Lpd Disc Time-out	030	30 ~ 500 (sec)

- *1 Acceptable HEX or ASCII code to input. Case-sensitive for ASCII code, on the other hand, HEX code is not.
- *2 Regarding Channel, the setting range varies depending on the destination of the printer.
- *3 AironetExtension (Setting to send KEY continuously from AP) is not supported.
- *4 Alphanumeric and symbols excluding [,] (comma) and ["] (double quotation).

[Certification]

Certificate is required for 802.1x authentication. There are two types of certificate such as Client Certificate and Root Certificate, and each of them is downloadable from its own website only. Time-out at the time of import is 10 seconds.

[Corresponding certification format]

- CA root certificate : X.509(cer, DER, PEM)
- Client certificate : PKCS#12(pfx, p12), X.509(cer, DER, PEM)
- Secret key : Key

* When the client certificate file is in PKCS#12 format, leave [secret key file name] blank.

7.4 LOCAL AREA NETWORK (LAN) ETHERNET AND WIRELESS LAN (cont'd)

[Connectable combination]

Security	IEEE 802.11	IEEE 802.11i	Encryption
None	None	None	None
WEP	Open System	None	WEP key
	Shared Key	None	
WPA	None	PSK	TKIP
		EAP-LEAP	
		EAP-TLS	
		EAP-PEAP	
		EAP-TTLS	
WPA2	None	PSK	AES
		EAP-LEAP	
		EAP-TLS	
		EAP-PEAP	
		EAP-TTLS	
Dynamic WEP	Open System	EAP-LEAP	WEP key
		EAP-TLS	
		EAP-PEAP	
		EAP-TTLS	
	Shared Key	EAP-LEAP	
		EAP-TLS	
		EAP-PEAP	
		EAP-TTLS	

*1 The following items should be specified for WPA-IEEE802.1x (TKIP).

Security Mode : WPA
WPA Authentication : EAP(IEEE802.1x)
WPA PSK Mode : TKIP
EAP Mode : EAP-LEAP / EAP-TLS / EAP-PEAP / EAP-TTLS
EAP User Name : (user name)
EAP Password : (password)

*2 The following items should be specified for WPA2-IEEE802.1x (AES).

Security Mode : WPA2
WPA Authentication : EAP(IEEE802.1x)
WPA PSK Mode : AES
EAP Mode : EAP-LEAP / EAP-TLS / EAP-PEAP / EAP-TTLS
EAP User Name : (user name)
EAP Password : (password)

For WPA-802.1x authentication, it is not necessary to set [WPA-PSK Setting].

Pre-Shared Key setting of [WPA-PSK Setting] must be configured when WPA mode is set to "PSK". Match "Data encryption: AES / TKIP" of [WPA Setting] with data encryption setting of access point. You cannot establish the connection to the access point if data encryption setting is set to "AUTO"(TKIP / AES Auto-detect).

7.4 LOCAL AREA NETWORK (LAN) ETHERNET AND WIRELESS LAN (cont'd)

[Restrictions]

- 1) Not supporting Atheros SuperG and XR.
- 2) Extended Aironet is not supported.
- 3) When AdHoc is in use, baud rate will be based on IEEE802.11b.
- 4) When AES is in use, the connection to AP by Broadcom will be unstable.
This is because Broadcom is equipped with AES based on 802.11Draft.
- 5) There is no guarantee of proper operation for DSA authentication of EAP-TLS.

Notes

For Both On-board LAN and Wireless LAN Interface

- 1) For the detailed On-board LAN/Wireless LAN interface settings, refer to the included [Setup Guide] and the Network Utility of [SATO Accessory CD-ROM].
- 2) To open/close Print data port (Port1024), Status port (Port1025) or Sending/Receiving port (Port9100), make sure to close and open the port at intervals of approximately 150ms to 200ms. If not having enough time from closing to opening the port, it may result in double connection.
If the host requests the connection to the port already connected (Port1024, Port1025 or Port9100), the printer accepts the request (establishing double connection); however, disconnects the second connection immediately.

For Wireless LAN Interface

- 1) Communication range and transmission rates between the host computer and the printer (Wireless LAN board) may change depending on the operating environment and conditions of radio waves.
- 2) In Infrastructure mode, the best operating environment and conditions of the radio field strength is Medium level (50 to 75%) or higher.
- 3) Communication data may be lost under the inappropriate circumstances for radio waves such as the mobile computing type of environment and actual operating conditions.
- 4) When multiple wireless network groups in nearby area, the frequency for the channel of each group has to be 5 or higher.
Example) When the channel of Group1 is [1], set the channel of Group2 to [6] or higher.
- 5) In 802.11 Ad hoc mode for wireless LAN board, LED will light constantly once the connection to PC is established. If the wireless LAN board is reset and the connection to PC is not established, LED will not light.

For On-board LAN Interface

- 1) Do not connect and disconnect the LAN cable while starting up the printer. Restart the printer if having a communication error due to connection/disconnection of LAN cable

8

APPENDIX

The following information is provided:

- 8.1 Optional Accessories - Cutter
- 8.2 Optional Accessories - Dispenser
- 8.3 Positions of sensors and options
- 8.4 15mm (0.6") Wide Wristband
- 8.5 Operation Mode Selection
- 8.6 Base Reference Point
- 8.7 Offset position Adjustment
- 8.8 Paper End
- 8.9 Ribbon End

8.1 OPTIONAL ACCESSORIES - CUTTER

Cutter should only be installed by SATO qualified servicing personnel.

8.1.1 To route the media when the cutter is installed

Loading of the media for cutter unit is similar to the usual procedure as explained in **Section 2.3 Loading Labels or Tags**.

8.1.2 Cut position Adjustment

- **Cutting of Labels**

The correct cutting position is at the label gap. Cutting onto the label must be avoided because the label adhesive that accumulates on the blade will affect cutter sharpness.

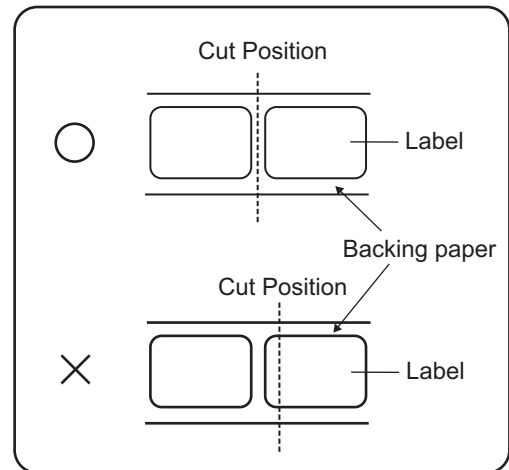

- **Cutting Media with Perforation**

As for media with perforation, **cutting on or in front of the perforated lines is prohibited**. Cutting in those locations could cause media jam and the printer to be malfunction.

The perforated line +1 mm (+0.04") is the cut prohibited zone (Fig. 1).

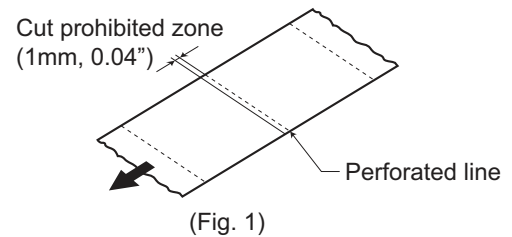

The folded perforated line +4 to +25 mm (+0.15" to +0.98") of fan-folded paper is the cut prohibited zone (Fig. 2).

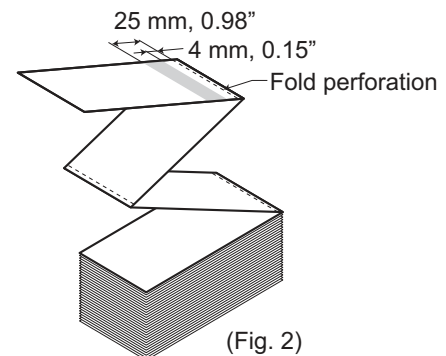

8.1 OPTIONAL ACCESSORIES - CUTTER (cont'd)

8.1.2 Cut position Adjustment (cont'd)

If the cutting position is not at the regular position as mentioned, use the Phillips tip of the yellow **microdriver** attached to the side of the media holder to adjust the potentiometer **VR3** located at the bottom right of the front panel for the cut position.



Yellow microdriver

- Turn left: The cut position moves in the opposite direction of the printing direction.
- Turn right: The cut position moves in the same direction as the printing direction.

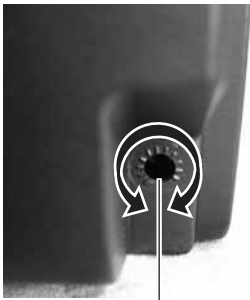

For cut position adjustment

8.1.3 Cutter replacement

Over time, the cutter loses its cutting ability and begins to show signs of wear. Replace the cutter unit when the blade becomes blunt and cut edges are rough. (Please contact to the authorised SATO Representatives for replacement.)

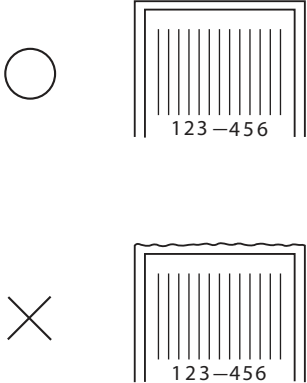

8.2 OPTIONAL ACCESSORIES - DISPENSER

Dispenser should only be installed by SATO qualified servicing personnel.

8.2.1 To route the label when the dispenser is installed

1. With the power supply off, pull the **cover open/close latches** on both sides of the printer toward you to unlock the top cover, and then open the **top cover**. Make sure that the cover rests firmly so that it will not fall forward and injure your hands.
2. With the thumbs position on the two corner of the **pressure bracket**, push the **pressure bracket** up and pull forward to open the **pressure bracket**.

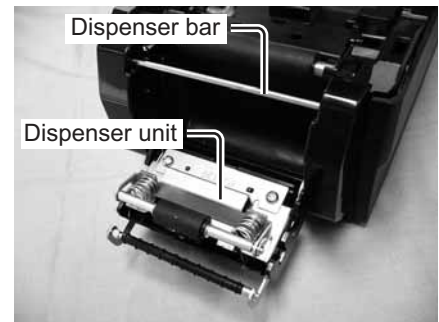
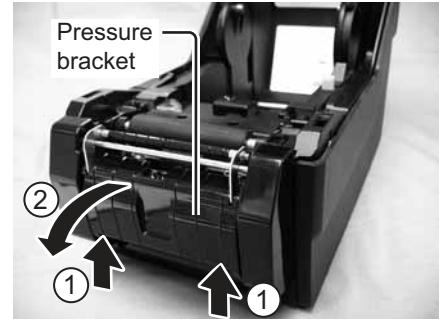

3. Peel off the first two leading label from the liner (backing paper) and then load the label roll on the **media holder**. After pulling out the leading liner (backing paper), pass the liner (backing paper) through the **media guides** and then pass over the **dispenser bar** so as to cover it. Then pass the liner (backing paper) under the **pressure bracket** as shown.

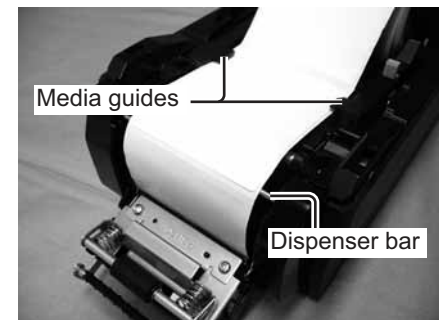

4. If the paper is not taut, roll the paper on the **media holder** so that the paper is taut. Next, tightly close the **pressure bracket** with the liner (backing paper) passing through it.



8.2 OPTIONAL ACCESSORIES - DISPENSER (cont'd)

5. Close the top cover until it clicks into position.

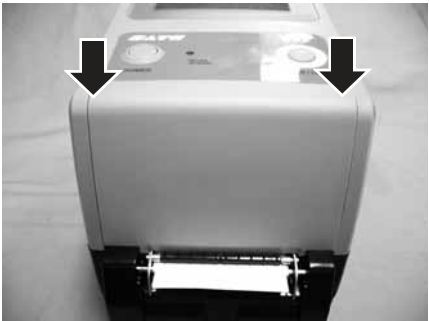

6. After loading of the label, turns on the power. The printer is online and the ON LINE (POWER) indicator lights green. When the printer is ready, press the FEED/LINE button to output an empty label and stop at the dispenser. This procedure is to ensure the label is loaded correctly.

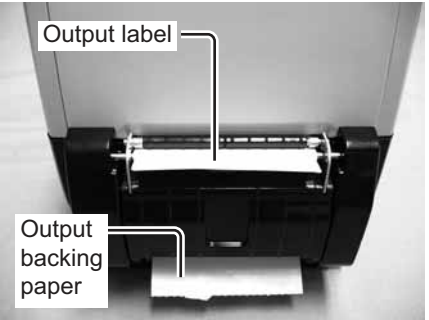

8.2.2 Stop position Adjustment

Normally, the label is dispensed to the point where 2 or 3mm (0.08" or 0.1") of the label remain on the liner (backing paper).

If the label is not dispensed at the regular position, use the Phillips tip of the yellow microdriver attached to the side of the media holder to adjust the potentiometer VR3 located at the bottom right of the front panel for the label dispensing stop position. After adjusting the stop position, dispense two or three labels to fix the stop position.



Yellow microdriver

- Turn left: The stop position moves in the opposite direction of the printing direction.
- Turn right: The stop position moves in the same direction as the printing direction.

Notes:

- There may be cases when the dispenser does not function properly due to the thickness of the labels used.
- Dispenser unit is effective for label pitch 22 to 100 mm (0.86" to 3.9"). However, label size limitation may vary with application conditions.
- Labels over 100mm (3.9") may curl at dispense due to the nature of the material. There is no remedy for this.

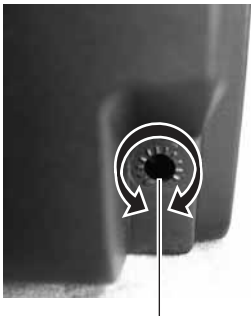

For label dispensing stop position adjustment

8.3 POSITIONS OF SENSORS AND OPTIONS

Only Center hole sensor and Gap sensor are in common use. No sensors interfere with each other.

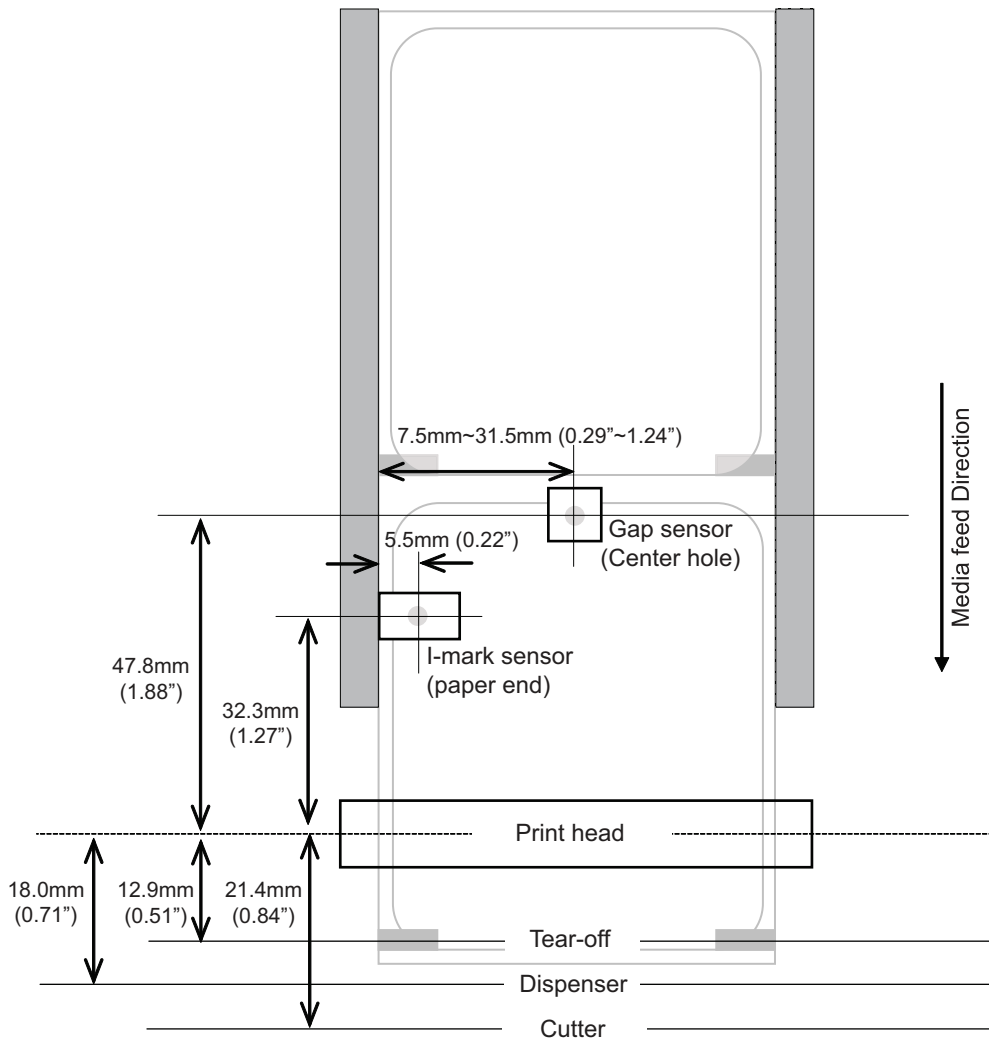

8.4 15MM (0.6") WIDE WRISTBAND

To distinguish the fastening hole of wristband (1) and tag hole (2), the length of tag hole (2) is designed to be 6mm (0.23").

The top of tag hole (2) becomes the print reference position.

When using this type of wristband, please set the Sensor Type to Transmissive sensor 2 (for Wrist band, no die cutting).

The usage of this wristband is similar to the one with I-mark (Die cutting).

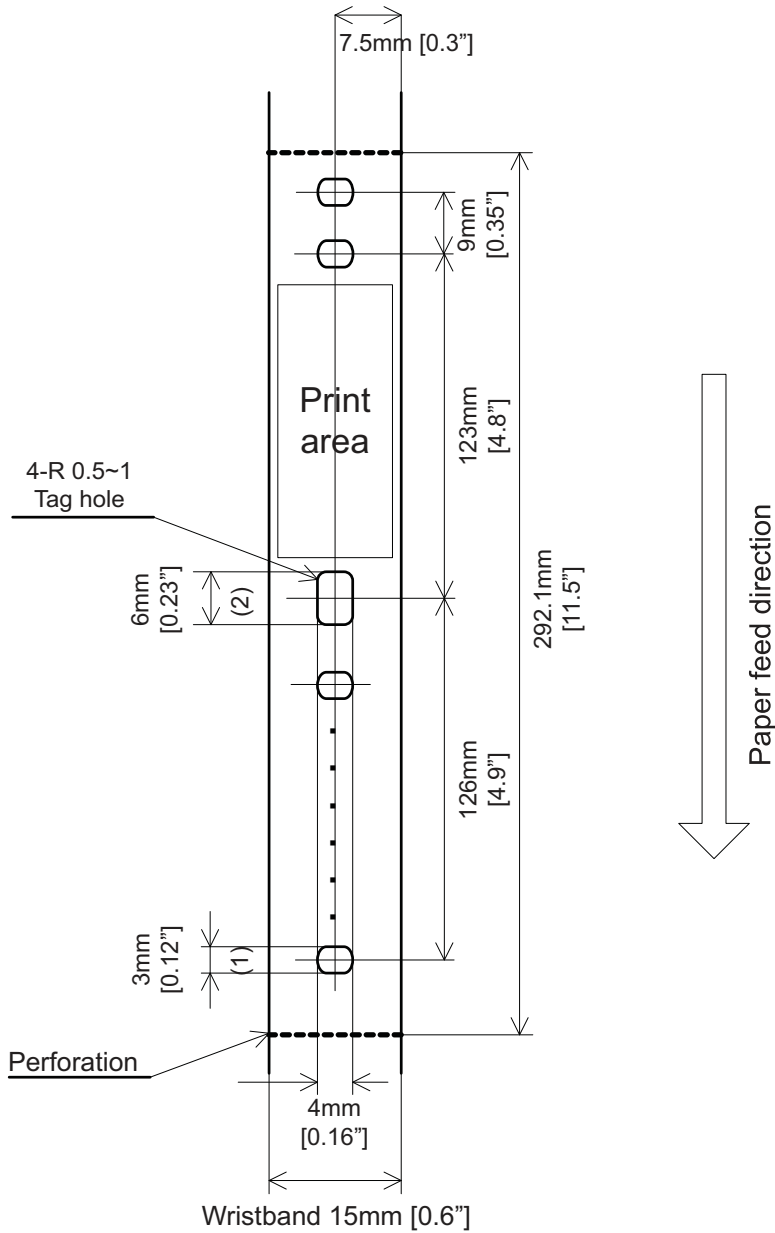

8.5 OPERATION MODE SELECTION

There are four modes of printer operation; Continuous, Tear-off, Cutter and Dispense mode. The differences are the ways that the label and paper backing is ejected. Before printer configuration, one must determine which mode will be used. This section identifies the functional differences among the four.

CONTINUOUS MODE

With this mode of operation, the media remains in position for printing at all times. To do so, means that the previous printed label is only available for removal when one to four additional labels have been printed (quantity is depended on label size). This mode of operation is specifically suited for printing bulk quantities to be applied later.

TEAR-OFF MODE

With this mode of operation, after printing, the printer feeds the first (outermost) label so that it is fully extended out of the printer's front for removal. Printing of the next label will not begin until the prior printed label has been removed. This mode of operation is specifically suited for immediate application at the time of print.

Upon removal of the prior printed label, the printer retracts the media so that the next label in line may be printed, then feeds. This cycle, repeats for each consecutive label.

CUTTER MODE

With the optional cutter unit installed and enabled, this mode of operation will cut individual printed labels or in multiples. The media will be advanced to the cutter blade, the label cut will occur, and the unprinted media will retract for positioning of the next print.

DISPENSE MODE

When the optional dispenser is installed and enabled, this mode of operation will peel the liner (paper backing) from the printed label as it is advanced to the printer's front. Once the printed label has been removed from the printer for application, the unprinted media will retract and position itself so the next label may be printed.

This operational mode is specifically applicable to print operations where the label is to be immediately adhered.

8.6 BASE REFERENCE POINT

Base reference point is the point to determine the print and cut positions.
 Base reference position differs depending on the print mode or the label pitch sensor to be used.

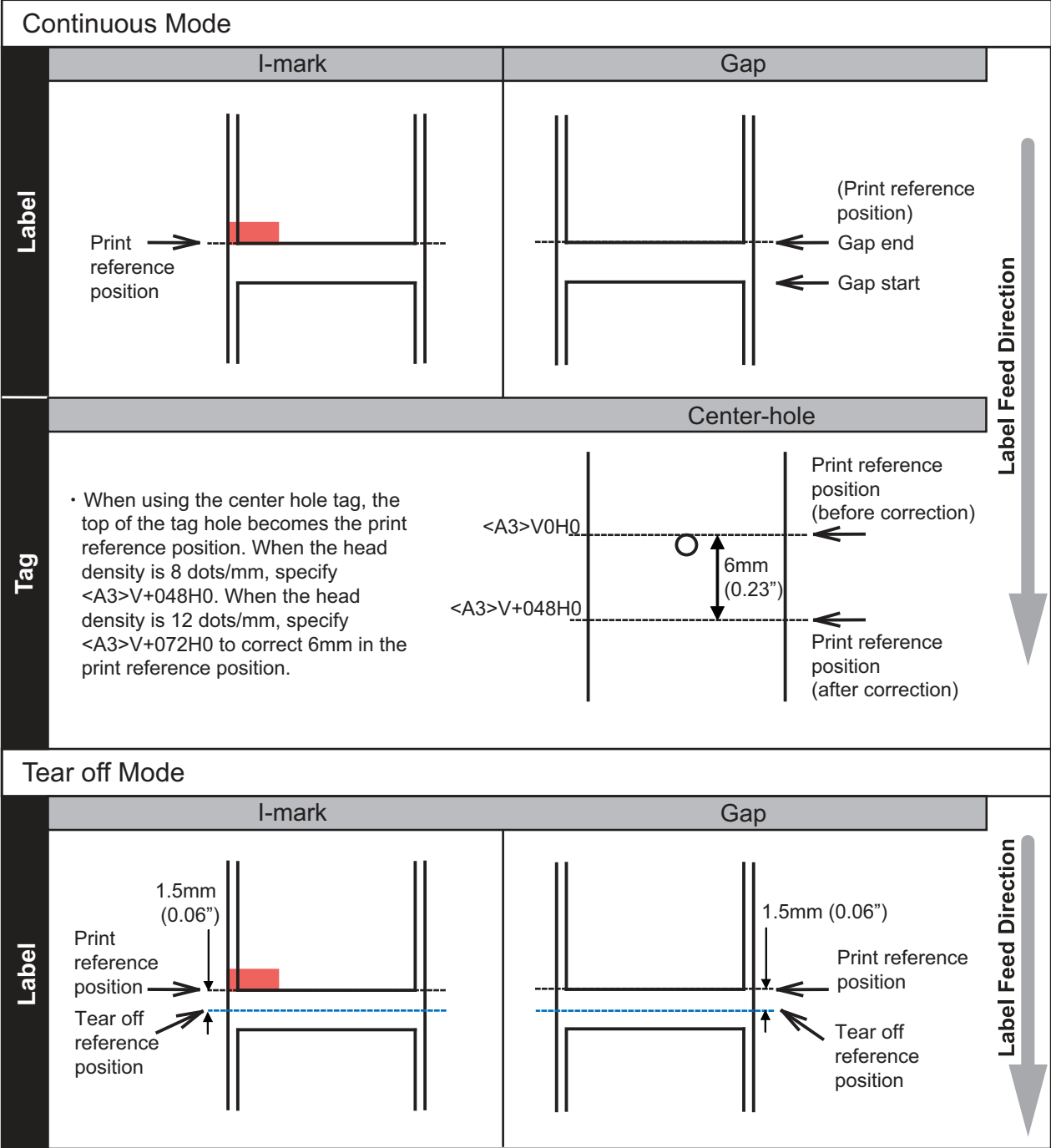

8.6 BASE REFERENCE POINT (cont'd)

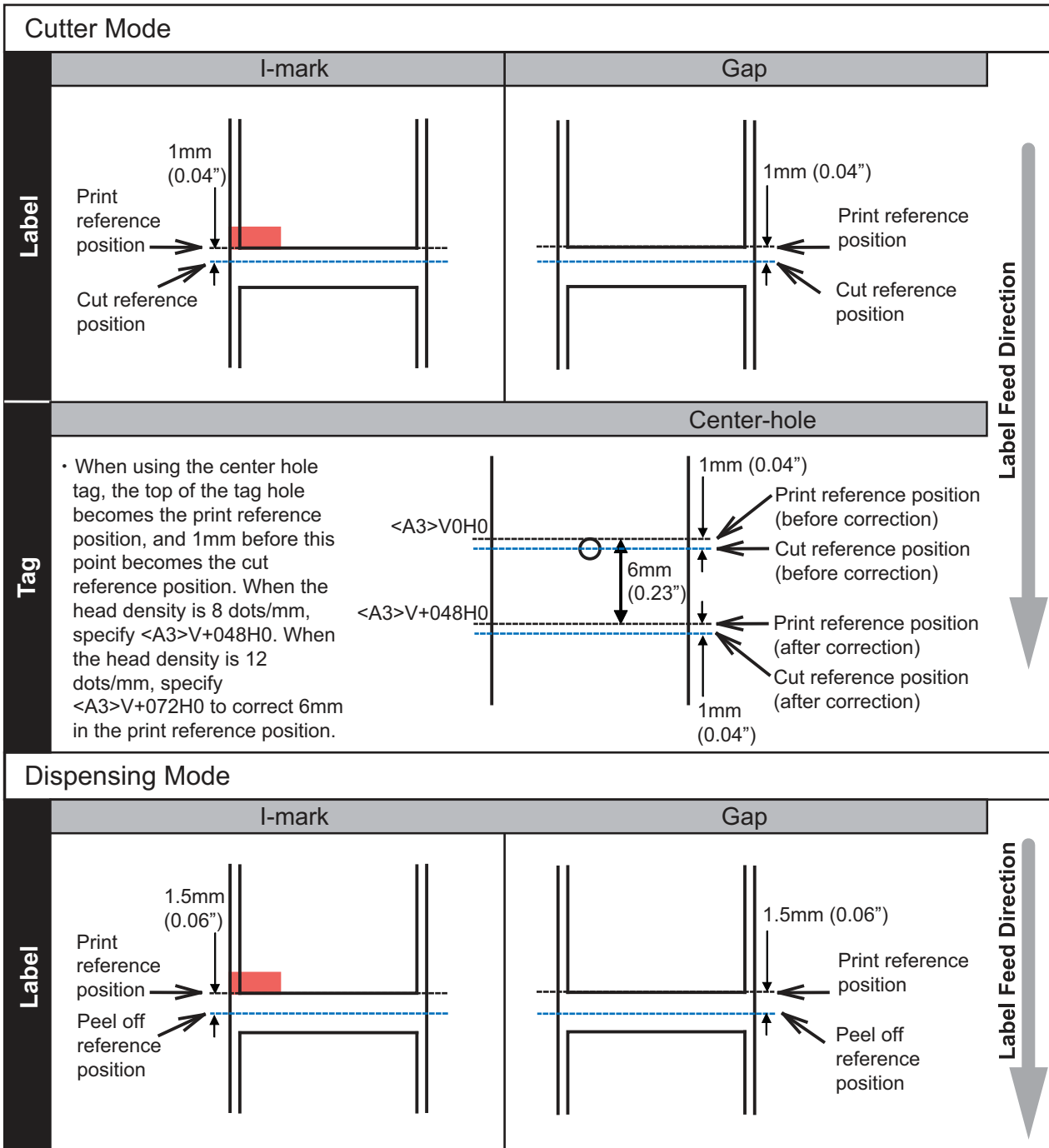

8.6 BASE REFERENCE POINT (cont'd)

8.6.1 Base Reference point Adjustment

Print Position Offset—which refers to the vertical and horizontal shifting of the entire print area, relative to the start position of printing (V=0, H=0), defined by default to be the bottom right hand corner of the label.

The Base Reference point can be adjusted by using the Printer Utilities Tool application or by sending <A3> command from the host.

The V setting is for the Vertical print offset. A positive (+) offset means the printing is shifted towards the print head; a negative (-) offset means shifting away from the print head. If the PITCH setting has been used to offset the vertical start position, then all Vertical offset adjustments are made relative to that start position.

The H setting is for the Horizontal print offset. The + or - prefix determines whether the offset is to the left or to the right of the reference point.

The default value of both positions is +000 dot. The maximum values that can be set for each is +/-396.

You may wish to print a test print after completing the adjustments to ensure they are correct. Refer to **Section 3.3 User Test Print Mode** for details.

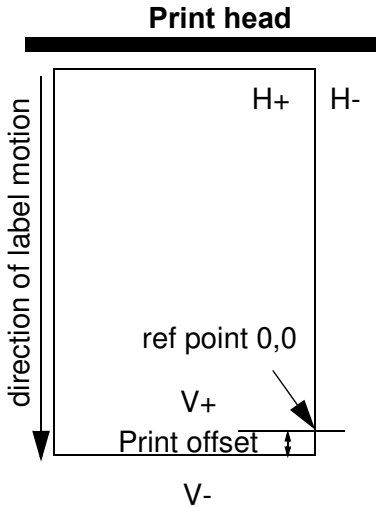

8.7 OFFSET POSITION ADJUSTMENT

This setting adjusts the option (Cutter, Dispenser, Tear off) stop position after a print out. By using **VR3** potentiometer, the stop position can be adjusted within the range of $\pm 3.75\text{mm}$ ($\pm 0.15''$). A positive value moves the leading edge of the label forward (away from the print head) while negative value moves the leading edge of the label back to the mechanism.

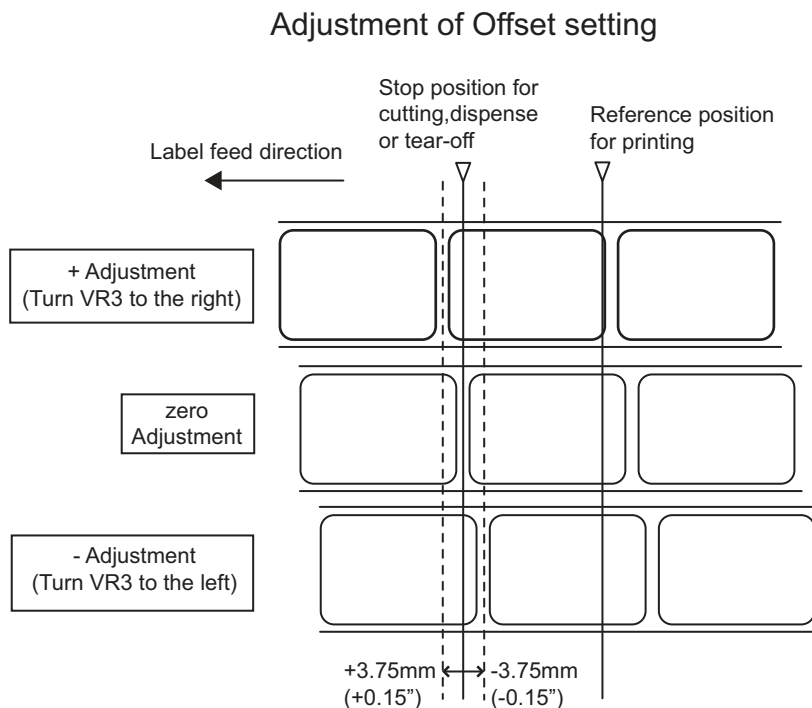

In addition to the above setting, the Offset position can also be adjusted by using SATO Utilities Tool application or by sending command <PO> from the host. The setting range is within ± 99 dots. (Except for Tear off mode: -60 dots to $+99$ dots). This setting is normally not necessary. Use **VR3** potentiometer on the printer for permanent setting.

8.8 PAPER END

8.8.1 Roll Label End

When the Label End is less than 10mm (0.4") from I-Mark

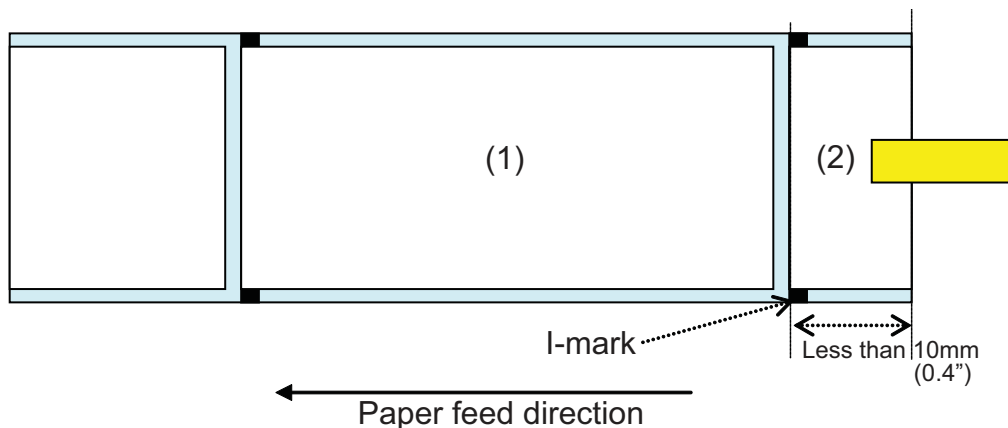

Printer behavior when paper end is detected:

- After completing the print of label (1), "Paper end error" will occur.
- In cutter mode, "Paper end error" will occur after cutting the label.
- After releasing the error, Label (1) will not be printed again.

When the Label End is More Than 10mm (0.4") from I-Mark

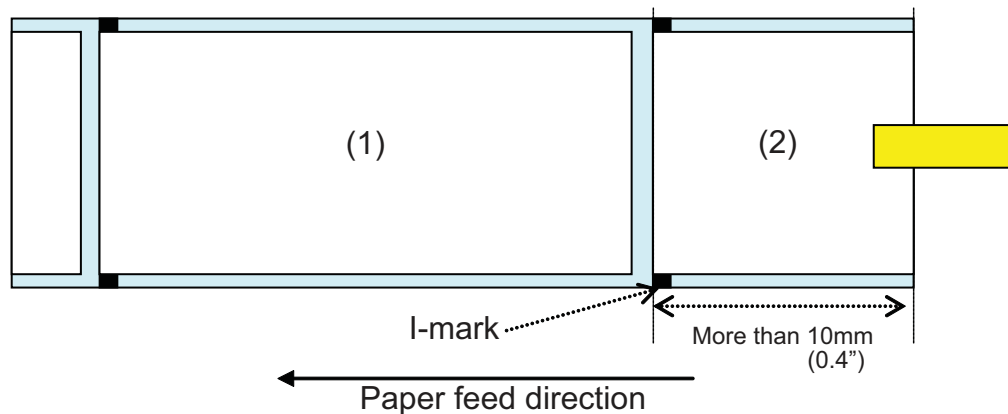

Printer behavior when paper end is detected:

- When the print of label (2) is in progress, "Paper end error" will occur.
- If an error occurs while printing, label (2) will be printed again after releasing the error. If the print job is completed at the time of error occurrence, label (2) will not be printed again.
- In cutter mode, cutting motion will not occur when having "Paper end error".

8.8.2 Fanfold Label End

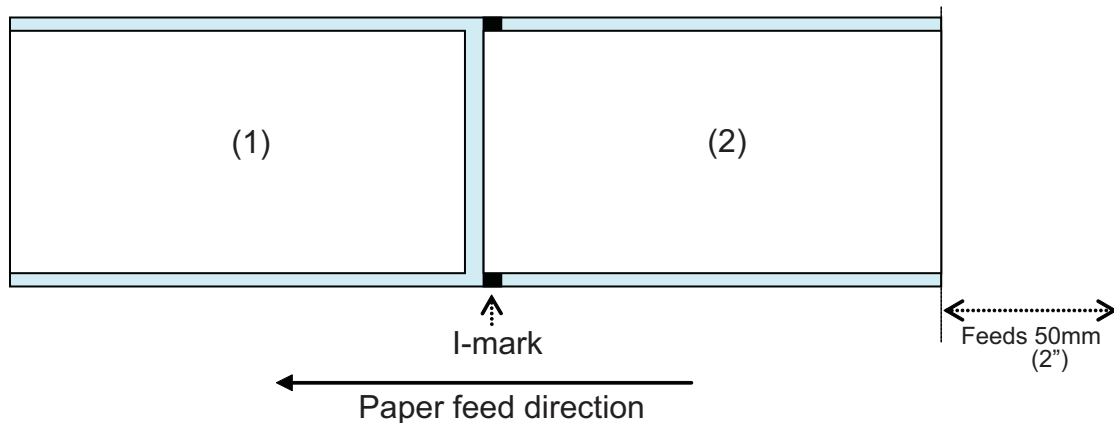

Printer behavior when paper end is detected:

- After printing and feeding label (2) 50mm (2"), "Paper end error" will occur.
- If an error occurs while printing, label (2) will be printed again after releasing the error. If the print job is completed at the time of error occurrence, label (2) will not be printed again. (Also, when the print job is completed while feeding the label 50mm (2"), the label will not be reprinted.)
- In cutter mode, cutting motion will not occur when having "Paper end error".

Note:

Paper end error is detected using the I-mark sensor. Therefore, using a tag with dark colored liner (dark colored tag) may result in paper end error. When using this type of tag, check if the tag is suitable for printing beforehand.

8.9 RIBBON END

Printer behavior when ribbon near end is detected:

- Ribbon near end can be detected by setting printing method to thermal transfer.
- When the ribbon remaining becomes 5 to 10m (0.2" to 0.4"), "Ribbon near end" will be detected. The status of ribbon near end will be returned if status request (ENQ) is made.

Printer behavior when ribbon end is detected:

- Ribbon end can be detected by setting printing method to thermal transfer.
- If the print job is completed at the time of "Ribbon end error", the label will not be printed again after releasing the error.
- If "Ribbon end error" occurs while printing, the label will be printed again after releasing the error.

9

SATO GROUP OF COMPANIES

SATO GROUP OF COMPANIES

Asia Pacific & Oceania Region

SATO ASIA PACIFIC PTE. LTD.

438A Alexandra Road #05-01/04,
Alexandra Technopark, Singapore 119967
Tel: +65-6271-5300
Fax: +65-6273-6011
Email: technical@satoasiapacific.com
www.satoasiapacific.com

SATO AUTO-ID MALAYSIA SDN. BHD.

No.25, Jalan Pemberita U1/49,
Temasya Industrial Park, Section U1,
40150 Shah Alam, Selangor Darul Ehsan,
Malaysia
Tel: +60-3-7620-8901
Fax: +60-3-5569-4977
Email: service@satosms.com.my
www.satoasiapacific.com

SATO AUTO-ID (THAILAND) CO., LTD.

292/1 Moo 1 Theparak Road,
Tumbol Theparak, Amphur Muang,
Samutprakarn 10270, Thailand
Tel: +66-2-736-4460
Fax: +66-2-736-4461
Email: technical@satothailand.com
www.satothailand.co.th

SATO SHANGHAI CO., LTD.

307 Haining Road, ACE Bldg,
10th Floor, Hongkou Area, Shanghai,
China 200080
Tel: +86-21-6306-8899
Fax: +86-21-6309-1318
Email: tech@satochina.com
www.satochina.com

SATO ASIA PACIFIC PTE. LTD.

Korea Representative Office
6F, Korea Housing Center,
Yeouido-dong 45-11, Yeongdeungpo-gu,
Seoul, Korea 150-736
Tel: +82-2-761-5072
Fax: +82-2-761-5073
Email: technical@satoasiapacific.com
www.satoasiapacific.com

SATO ASIA PACIFIC PTE. LTD.

India Representative Office
Regus Level 2, Connaugh Place,
Bund Garden Road, Pune. 411001, India
Tel: +91-20-4014-7747
Fax: +91-20-4014-7576
Email: technical@satoasiapacific.com
www.satoasiapacific.com

SATO AUSTRALIA PTY LTD.

1/1 Nursery Avenue, Clayton Business
Park, Clayton, VIC 3168 Australia
Tel: +61-3-8814-5330
Fax: +61-3-8814-5335
Email: enquiries@satoaustralia.com
www.satoaustralia.com

SATO NEW ZEALAND LTD.

30 Apollo Drive, Mairangi Bay
Auckland, New Zealand
Tel: +64 9-477-2222
Fax: +64 9-477-2228
Email:
global.warranty@satonewzealand.com
www.satonewzealand.com

European Region

SATO LABELLING SOLUTIONS EUROPE GmbH (BELGIUM)

Leuvensesteenweg 369,
1932 Sint-Stevens-Woluwe, Belgium
Tel: +32-2-788-80-00
Fax: +32-2-788-80-80
Email: info@nl.satoeurope.com
www.satoeurope.com

SATO LABELLING SOLUTIONS EUROPE GmbH (GERMANY)

Ersheimer Straße 71,
69434 Hirschhorn, Germany
Tel: +49-6272-9201-160
Fax: +49-6272-9201-347
Email: service@de.satoeurope.com
www.satoeurope.com

SATO LABELLING SOLUTIONS EUROPE GmbH (NORWAY)

Hovfaret 4 0275 Oslo, Norway
Tel.: +47-225-106-70
Fax: +47-225-106-71
Email: kundeservice@satonorge.com
www.satoeurope.com

SATO LABELLING SOLUTIONS EUROPE GmbH (NETHERLANDS)

Techniekweg 1b, 3481 MK Harmelen,
Netherlands
Tel.: +31-348-444437
Fax: +31-348-446403
Email: info@nl.satoeurope.com
www.satoeurope.com

SATO LABELLING SOLUTIONS EUROPE GmbH (ITALY)

Viale Europa 39/1,
20090 Cusago, Milano, Italy
Tel.: +39-2-903-944-64
Fax: +39-2-903-940-35
Email: info@it.satoeurope.com
www.satoeurope.com

SATO LABELLING SOLUTIONS EUROPE GmbH (SWITZERLAND)

Allmendstraße 19,
8320 Fehraltorf, Switzerland
Tel: +41-44-954-84-00
Fax: +41-44-954-84-09
Email: info@ch.satoeurope.com
www.satoeurope.com

SATO LABELLING SOLUTIONS EUROPE GmbH (AUSTRIA)

Niederlassing Austria
Jochen-Rindt-Straße 13
1230 Wien, Austria
Tel: +43-2762-52690
Fax: +43-2762-52018
Email: info@at.satoeurope.com
www.satoeurope.com

SATO LABELLING SOLUTIONS EUROPE GmbH (DENMARK)

Naverland 29A DK-2600
Glostrup, Denmark
Tel.: +45-43204700
Fax: +45-43204709
Email: info@dk.satoeurope.com
www.satoeurope.com

SATO POLSKA SP. Z O.O.

ul. Wrocławska 123, Radwanice,
55-015 Św. Katarzyna, Poland
Tel: +48-71-381-03-60
Fax: +48-71-381-03-68
Email: info@sato.pl
www.sato.pl

SATO IBERIA S.A.

Dels Coralls Nous, 35-39
Pol. Can Roqueta, 08202 - Sabadell
Barcelona, Spain
Tel: +34-902-333-341
Fax: +34-902-333-349
Email: info@es.satoeurope.com
www.satoeurope.com

SATO FRANCE S.A.S.

Parc d'Activités, Rue Jacques Messenger,
59 175 Templemars, France
Tel: +33-3-20-62-96-40
Fax: +33-3-20-62-96-55
www.satoeurope.com

SATO UK LTD.

Valley Road, Harwich,
Essex CO12 4RR, United Kingdom
Tel: +44-1255-240000
Fax: +44-1255-240111
Email: enquiries@satouk.com
www.satouk.com

American Region

SATO AMERICA, INC.

10350-A Nations Ford Road, Charlotte,
NC 28273, U.S.A.
Tel: +1-704-644-1650
Fax: +1-704-644-1662
www.satoamerica.com

SATO LABELING SOLUTIONS AMERICA, INC.

1140 Windham Parkway, Romeoville,
Illinois 60446, U.S.A.
Tel: +1-800-645-3290
Fax: +1-630-771-4210
www.satolabeling.com

- Extensive contact information of worldwide SATO operations can be found on the Internet at www.satoworldwide.com